



APPLICATION

The new Francis Bus Premium range of variable speed Remote Controlled Searchlights incorporate the design features required to successfully operate searchlights in the most demanding product operating environments on land and sea.

Francis Searchlights have developed and improved all remote controlled searchlights across the range still further by adding full variable speed, a new modern and sleek joystick control panel, using membrane and LED technology, offering Bus Control.

The Francis bus (FBUS) is a custom communication protocol based on RS485 two-wire bi directional communication hardware. The system provides a simple bi directional link between searchlights and control panels.

The FR560RC Range Explorer is a high quality large range compact remote control searchlight. These units are particularly suitable for use on patrol craft, custom vessels and general marine applications.

SPECIFICATION

- Tungsten Halogen Light source
- Toughened super clear Optiwhite front glass.
- Parabolic glass reflector
- Constructed from marine grade materials and fixings
- Powder coated and stove enamel paint finish.
- Pan rotation 385°
- Tilt elevation control +30°, -35°.
- Variable speed LED joystick, with auto home position.
- RS485 connectivity. Dimmable Control Panel.
- Variable Rotation Speed 1 to 23°/sec (Pan)
- Variable Elevation Speed 1 to 8°/sec (Tilt).
- Heater fitted in gearbox & optional in barrel
- Operational temp -50°
- Remote lamp focus, 5.5° spot to 24° flood.
- Sealing - IP66 Gearbox, IP56 Searchlight
- Searchlight weight 60kgs,

Francis Searchlights Limited
Union Road, Bolton, BL2 2HJ, UK
Tel 44 (0) 1204 558960 Fax 44 (0) 1204 558979
Email sales@francis.co.uk Web site www.francis.co.uk

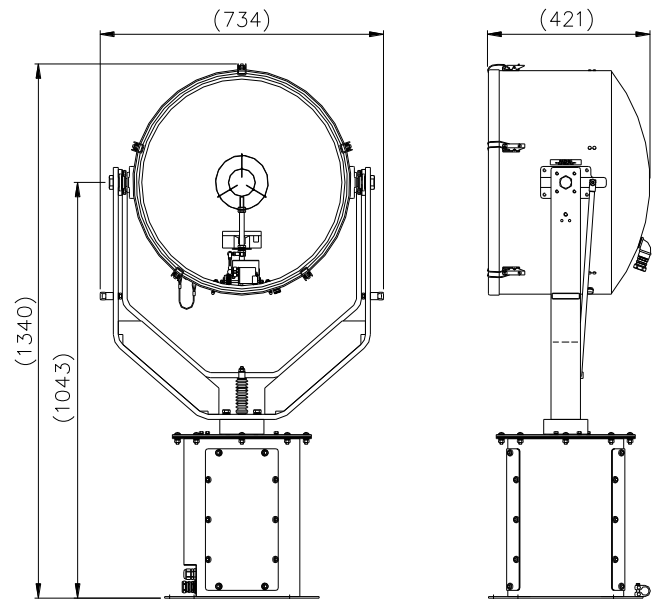

ALL DIMENSIONS IN MILLIMETRES

Base fixing details:

4 holes 12.5 Ø equi-spaced on a 350mm PCD
Joystick panel 120 x 120mm (106 x 106mm cutout)

Part Numbers

Type	Supply	Watts	Part No
FR560RC	115/230v	1Kw	A7132
FR560RC	115/230v	2Kw	A7133

Optional Controls:

Program Record Function
Computer Control Software
Azimuth LED Control Panel
Master Control Panel (control up to 10 Searchlights)
Slave Control Panels (with full control)
Fiber Optic/TCP/IP Connections

Volts	Lamp Life	Range @ 1 Lux	PBCP X 1000	Div	Watts	Lamp Part No
115v	750 hrs	1550m	2450	5°	1000w	D1809
115v	400 hrs	2030m	4121	5.5°	2000w	D1823
230v	750 hrs	1550m	2450	5°	1000w	D6715
230v	400 hrs	2030m	4121	5.5°	2000w	D4604

For more information contact: