



## User Instruction & Installation Manual

FX380 Manual Control  
1Kw Xenon Searchlight



### Product Reference Number:

A2770 – 115v Deck	A2771 – 240v Deck
A2772 – 115v Deck Pedestal	A2773 – 240v Deck Pedestal
A2774 – 115v Cabin	A2775 – 240v Cabin
A2776 – 115v Cabin Pedestal	A2777 – 240v Cabin Pedestal

#### Manufacturers details:

Francis Searchlights Ltd  
Union Road, Bolton  
Lancashire, BL2 2HJ, UK  
Tel: +44 (0) 1204 558960  
Fax: +44 (0) 1204 558979  
<http://www.francis.co.uk>  
E-mail: [sales@francis.co.uk](mailto:sales@francis.co.uk)

#### Distributor details:

Manual Part Number: C20332  
Issue : 11

# CONTENTS

- 1 - Introduction
- 2 - Safety Precautions
- 3 - Technical Information
- 4 - Unpacking and Installation Instructions
- 5 - Electrical Installation
- 6 - Operating Instructions
- 7 - Fault Finding
- 8 - Maintenance and Servicing
- 9 - Wiring Diagram & General Assembly Drawings
- 10 - Spare Parts List

# 1 - Introduction

**It is imperative that this manual is read carefully and understood before installing your equipment. For your future reference please keep this manual in a safe place.**

Thank you for specifying a product from the Francis Searchlights range. All Francis products are designed to give complete customer satisfaction and are manufactured to the highest engineering standards in order to ensure optimum performance and service life.

The Francis Xenon range combine features proven over many years service in the most hazardous conditions in both marine and land installations.

In order to prolong the life and performance of your product, we recommend that you only specify Francis Searchlights spare parts. This will also ensure that any warranties on your equipment will not be invalidated. Information on spares ordering and parts is provided in this manual.

Should you ever need to contact Francis Searchlights Ltd. regarding your equipment, please quote the Product Serial Number at all times.

## 2 - Safety Precautions

The following instructions must be adhered to, in order to ensure a safe working environment and the safety of the user.

**Note: When unpacking or manoeuvring the searchlight into its fixing position, the lifting handles must be used in order to prevent damage to the equipment or personal injury.**

- Because of the high internal pressure within the lamp, there is a risk of explosion in either a hot or cold state;
- During operation this lamp emits intense UV radiation which is harmful to the eyes and skin. Suitable protection should be worn;
- The high luminance of the arc can cause severe damage to the eye if viewed directly. ALWAYS wear suitable protective goggles when viewing the lamp;
- Always use protective jackets supplied with the lamp;
- Should it be necessary to examine the lamp with the front bezel removed, always use a protective shield and wear goggles to ensure a safe working environment;
- Searchlights get hot. Never touch the unit when lit and always allow 15 to 20 minutes for cooling down after turning the searchlight off;
- Never place anything on or cover the searchlight when in use;
- Ensure the lamp has cooled sufficiently before removal;
- If undue force appears necessary to remove the lamp, the equipment should be inspected by a competent person or contact the manufacturer;
- When disposing of lamps there are several options available:
  - Return the lamp, via the supplier, to the lamp manufacturer in its complete packaging
  - Because of the cold internal pressure of the lamp is approximately 8 bar, the lamp must first be depressurized before disposal. Place the lamp, in its protective jacket, in a plastic bag and drop from a height of 1 to 2 metres onto a hard surface;
- XBO lamps do not contain materials which are harmful to the environment and thus are not subject to special waste disposal regulations;
- Due to the vast range of lamps available it may appear possible that more powerful lamps can be used in the equipment than for which it was designed. Even when the unit will physically accept a higher wattage lamp, this substitution is not recommended and is dangerous. This action will also void any warranties on the equipment;
- Always refer to the lamp manufacturers technical data when dealing with lamps.

### 3 - Technical Information

This product has been designed to operate in accordance with the product specification. The FX380 1000 watt searchlight has the following features:

- All marine grade materials and fixings;
- Electronic power supply unit;
- Parabolic glass reflector;
- Stove enamel painted;
- Full 360° horizontal rotation;
- Vertical movement Deck & Deck Pedestal  $\pm 40^\circ$ , Cabin & Cabin Pedestal  $+40^\circ -20^\circ$ ;
- Internal self-regulating heater.

The searchlight also performs to the following optical data:

- Xenon light source;
- Lamp Wattage - 1000 Watts;
- Supply voltage – 208v-253v or 100v-132v;
- Peak Beam Candlepower - 45,000,000 lux;
- Range - 6,700 metres;
- Divergence - 1.5°;
- Temperature range -50°C.

In order that the searchlight operates correctly it is imperative that competent personnel are responsible for the installation, operation and servicing of this equipment. Failure to adhere to this advice may cause premature failure or incorrect operation of the searchlight, which may damage the equipment or cause personal injury.

Technical information on the Irem Power Supply Unit and Ignitor are included overleaf. For more detailed information please contact the manufacturer.

PSU ref.:       PX-50 N  
Ignitor ref.     AS-16040A

Power Supply fixings centres 450 x 180 using M6 screws.

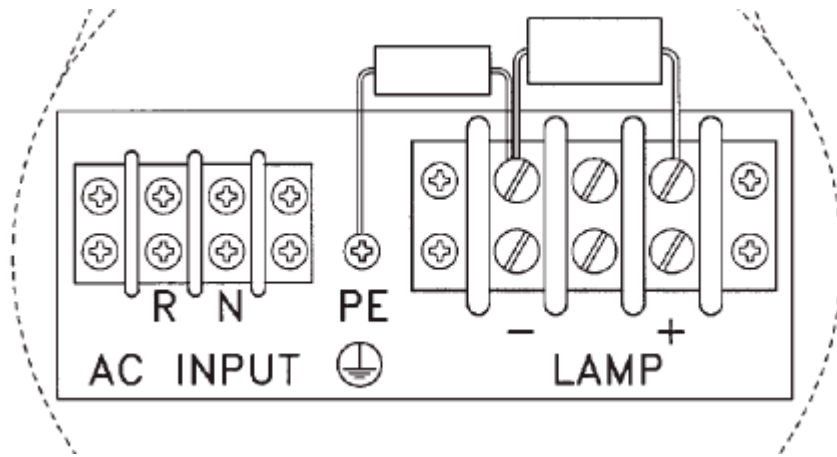

R = Live      N = Neutral      PE = Earth      Lamp - + = DC Output

Model	Lamp power [W] (approx.)	Max. input current [A]	AC input voltage/frequency [V - Hz]	AC input voltage range [V]	DC current range [A]	DC output voltage range [V]	No-load voltage range [V]	Pk to pk current ripple
PX-40N	700	10	230 - 50	208 - 253	36 - 45	16 - 22	125 - 170	<6%
	700	10	220 - 60	208 - 230	36 - 45	16 - 22	125 - 170	<6%
PX-50N	1000	11	230 - 50	208 - 253	30 - 50	20 - 25	120 - 170	<6%
	1000	11	220 - 60	208 - 230	30 - 50	20 - 25	120 - 170	<6%
PX-50N	1000	23	110 - 60	100 - 132	30 - 50	20 - 25	120 - 170	<6%

Marking: CE  
 Operating temperature: 0°C to 40°C  
 Storage temperature: -20°C to +60°C  
 Cooling: free convection  
 Degree of protection: IP20  
 Efficiency: >0.8

### Outline drawing

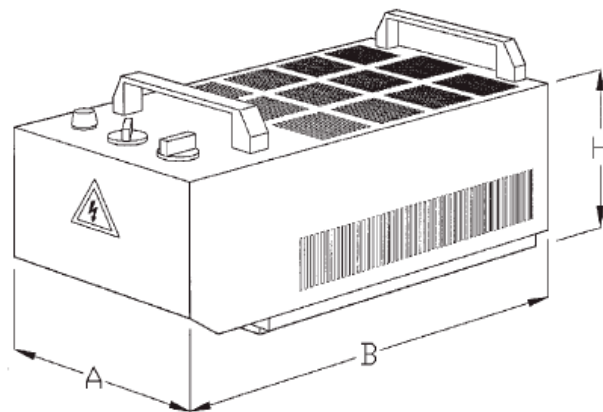

Model	Dimensions [mm]			Weight [kg]
	A	B	H	
PX mod.	245	595	238	56

## AS series

### Introduction

These igniters are expressly designed to strike Xenon, Xenon-Mercury, Mercury, Metal Halide and similar arc lamps. They produce the high voltage, high frequency starting potential required to get the gas in the lamp to ionize and make the current flow possible.

The **AS** igniters meet the lamp manufacturers' recommendations to ensure immediate and correct ignition of the lamp when cold or in any cooling stage.

They should be installed close to the lamp (but thermally shielded from it); the high voltage lead must be as short as possible and carefully insulated to prevent corona loss and reduction of strike energy. The ambient temperature must not exceed 60°C.

Some models are equipped with a built-in special function relay allowing automatically cycled or timed ignition. Also this relay prevents the igniter from striking when the lamp is ON or if the no-load voltage to the lamp is not correct. As far as the insulation class, this device can be considered Cl. II (as per IEC 536), but it must be grounded for interference suppression.

### Block diagram

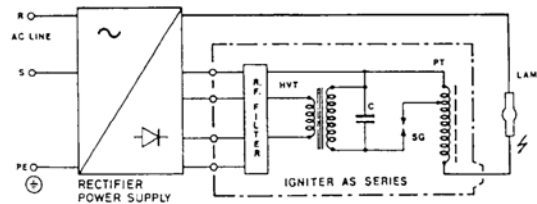

### Outline drawing

AS-3040

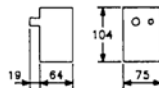

AS-8030

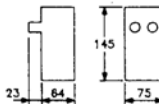

AS-16040/A

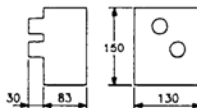

### AS Series range

Models	AC input (50-60Hz)		H.V. output KV	Lamp current A	Weight Kg.
	Volt	A during ignition			
<b>AS-3040</b>	230V	0.8	40	30	1.3
<b>AS-8030</b>	±10%	1.5	30	80	1.5
<b>AS-16040A</b>		3.8	40	160	3.5

The suffix 'A', used for the model AS-16040A, means that it has a built-in relay system for automatic or short timed ignition.

## 4 - Unpacking and Installation Instructions

The following instructions should be read and fully understood prior to installing the equipment to ensure that the correct procedures are followed and all safety precautions are observed.

**Note: If the equipment has been in storage for a considerable amount of time, it is advisable to conduct a routine maintenance check on all parts before installation.**

### Safety Precautions

This equipment should not be connected to an electrical supply before being installed. Installation procedures should be adhered to in order to ensure a safe working environment and reduce the risk of damage or personal injury.

### Preparing the Mounting Position

Mark out and drill the fixing holes through the deck. Fit the 'O' ring in position and bolt the searchlight base securely. On an uneven surface it is necessary to use a suitable sealant, such as silicone, in order to ensure a weatherproofed joint. If anti-vibration mounts are to be fitted, the fixing holes for the mounts should also be marked out and drilled. Prior to manoeuvring the searchlight into its' fixing position, the AV mounts should be fitted to the base. When in the desired position, bolt the searchlight firmly down.

## 5 - Electrical Installation

For safety purposes, only competent personnel should perform the electrical installation. All equipment should be installed to current Electrical Regulations and Standards.

In order to obtain the maximum light output from the searchlight, it is essential that the full operating voltage of the lamp fitted be applied to the lampholder contacts.

### Method of Electrical Connection

- 1) Disconnect the supply before working on the electrical system;
- 2) The searchlight must be connected to a fused electrical supply, using suitably sized cable;
- 3) If the searchlight is located a considerable distance from the supply, provision must be made in the cable size in order to overcome the voltage drop.

**The PSU should NOT be positioned no more than 5 meters away from the Searchlight.**

The following table below indicates the maximum length of cable to be used for the AC supply cable, from the control panel to the searchlight:

Searchlight	115v 1Kw	240v 1Kw
Cable Size (mm <sup>2</sup> )	Distance Max	Distance Max
1.5	17 MTRS	75 MTRS
2.5	28 MTRS	123 MTRS
4	44 MTRS	195 MTRS
6	68 MTRS	304 MTRS
10	115 MTRS	509 MTRS

- 4) Whenever possible cable terminations should be made below deck and with approved terminal devices;
- 5) If a spare auxiliary fuse or circuit breaker is not available, one of the correct type and rating should be fitted and connected to a positive supply. It is advisable to locate a bus bar or main connection and avoid any direct connection to the supply;
- 6) For ease of use, a single pole switch, of the appropriate rating, should be fitted in a convenient location. All cable lengths should be kept to a minimum.

## Installation Guidelines

A typical installation and connection routine for the searchlights is as follows:

Referring to wiring diagram X4737, a supply is fed to the PSU, which then provides a common feed to all other functions and equipment.

Cables required to be connected by the customer: -

4 core 4.0mm cable from the PSU into the Searchlight, doubling up the pairs.

3 core 1.5mm cable from the PSU into the Searchlight.

3 core 1.5mm cable to the Heater in the Searchlight.

(customer may need to provide a suitable junction box to extend these three cables – 3 metres supplied) & the mains cable to the PSU (to be supplied by the customer). The searchlight head is pre-wired.

When the light is in operation the output from the PSU should be approximately 19v dc at 50amps.

## Basic Operation

When the searchlight is switched on a 240v or 115v supply is fed to the PSU and linked to the ignitor. Also from the PSU, a dc output is fed to the lamp.

The ignitor ionises the gas within the lamp and this strikes the light.

## Notes for Use of Irem PSU

The Irem PSU used on the 1Kw searchlight has two external switches allowing 12 different output values. Upon installation of the searchlight, and connection to an electrical supply by a qualified Electrical Engineer, voltage and current readings should be taken to ensure that the lamp is operating at its' optimum values.

For guidance purposes, the switch settings should be set at 'LOW' and '4' prior to striking the lamp. Upon striking, the running wattage of the lamp can be calculated by using the equation:

$$P = VI$$

Where P= Power (watts)

V= Voltage (V)

I = Current (Amps)

Instruments required: D.C. Ammeter  
Multimeter

## Procedure

- 1) With the multimeter, test the DC voltage in the searchlight head. This should be a approximately 17/18 volts.
- 2) With the D.C ammeter, test the current of the red DC cable at front of searchlight. It should read approximately 55 to 60 amps.
- 3) Multiply these readings together, as shown above, to obtain the desired wattage required, usually about 960watts.

For example, if it is found that upon calculation the lamp is only running at 800watts, then alterations can be made by 'stepping up' the switch. Use the fine adjustments to obtain the correct operating characteristics for the lamp in order to ensure optimum life and performance. At each 'step up', the power should be re-calculated by following the above procedure until the ideal setting is achieved.

The 'LOW' and 'HIGH' setting on the Irem PSU allows large increases in output voltage, whereas the small steps 1 – 6 allow fine adjustment.

For information purposes, the values below where recorded at the FSL in order to provide customer guidance. Please note that these values where recorded with no load present:

Setting	DC Output (V)
Low & 1	92
Low & 2	98
Low & 3	102
Low & 4	106
Low & 5	111
Low & 6	115
High & 1	105
High & 2	112
High & 3	117
High & 4	123
High & 5	129
High & 6	135

### Notes:

- Always set output slightly below maximum power to ensure optimum lamp life and a safe working environment;
- Overrunning the lamp will severely effect the operation of the lamp and its' lifetime. Continuous operation in this mode is extremely hazardous and may cause the lamp to shatter.

## Fitting instructions for the 1Kw xenon lamp

Referring to the diagram overleaf:

- 1) Unfasten eight latches (A) on the front and rear of the searchlight;
- 2) Remove the front bezel (B) and rear bezel (C) assemblies;
- 3) Unscrew the two M6 hexagon screws (D) from the front lampholder mounting block (E) and remove the front lampholder assembly from the mounting bracket;
- 4) Loosen the knurled screw on the front (F) and rear (G) lampholder assemblies;
- 5) The lamp can now be inserted, make sure that the negative (cathode) end of the lamp is towards the rear of the searchlight & the cathode (-ve) adaptor is securely fastened to end of lamp;
- 6) Tighten the knurled screw (G) on the rear lampholder assembly to hold the lamp in position;
- 7) Fasten the front lampholder mounting block back in position, it will be necessary to pull the front socket against its spring to fit over the lamp. When in place tighten the front knurled screw (F);
- 8) Fasten the front and rear lampholder leads as wiring diagram, ensuring the connections are secure;
- 9) The front bezel and rear bezel can now be replaced;
- 10) Removal is the reverse of the above. When replacing the lamp retain cathode (-ve) adaptor C13544-37 for re-use. (See instruction 5 above)

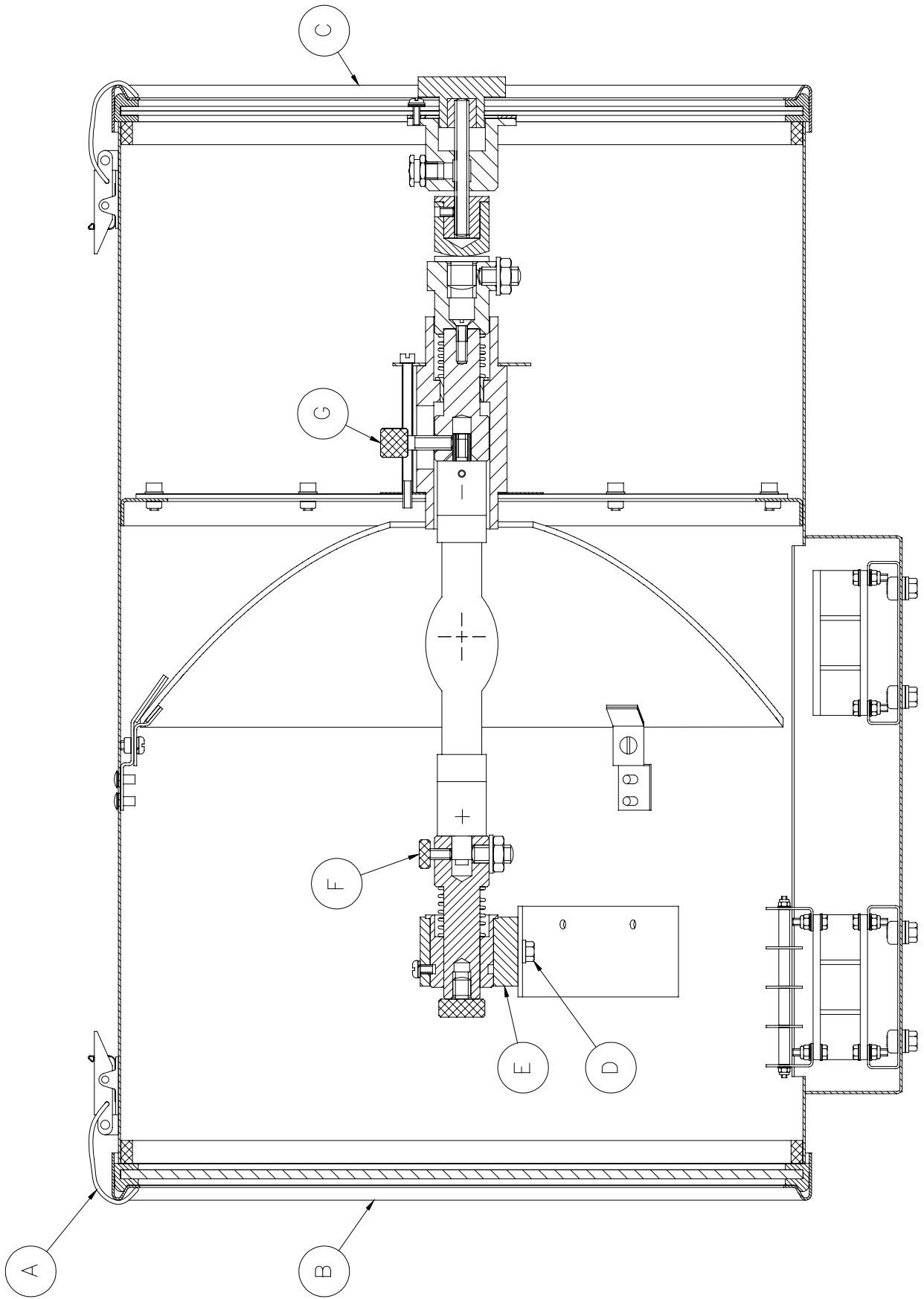

[Back To Top](#)

## 6 – Operating Instructions

This equipment is designed for use out of doors, in free air. Never place anything on, or cover the searchlight when in use as this may present a hazard.

The PSU should be housed below deck/in doors. Never leave the PSU exposed to weather conditions.

The searchlight can be positioned using the elevation and baseplate lockwheels. When in the desired position the lockwheels must be securely fastened to prevent damage.

The beam of the searchlight can be adjusted to give a variety of beam types. By turning the focus lockwheel positioned on the Rear Dome clockwise/anti-clockwise, the lamp holder mechanism moves through spot to flood positions. When the desired beam is achieved simply release the lockwheel.

Please note that it is advisable to leave the heater permanently on in order to remove condensation from the searchlight head. The heater specified on this equipment is self-regulating and will shut off when it reaches the dew point temperature.

**This product should not be used for any purpose other than for which it was designed. Any modifications to the product should not be undertaken without consulting the manufacturer.**

## Setting to Work

Safe service in use necessitates the strict observance of the following precautions.

- Any article fabricated from quartz or glass is inherently fragile and care should therefore be taken, at all times, when handling lamps;
- Eye protection must be worn when handling lamps that have been removed from their packaging materials. The protective jacket should not be removed from the lamp for safety reasons, as there is a remote possibility of the lamp shattering violently, especially if it is subjected to mechanical shock or vibration;
- Ensure that the power rating of the Xenon lamp to be fitted is suitable for the lamphouse and power supply equipment (rectifier);
- Always isolate the equipment from the supply before inserting a lamp;
- Before inserting the lamp ensure that all contacts are clean. Contacts must be renewed at the slightest sign of corrosion. Sanding or filing down corroded areas is not recommended as this will only make the conducting surface between the pin and lampholder smaller, thus causing the lamp to overheat;
- The inert gas (Xenon) used in XBO lamps are under a pressure of several bar even when the bulb is cold. FOR SAFETY REASONS THE LAMP MAY ONLY BE INSERTED INTO THE LAMPHOUSE WITH THE PROTECTIVE JACKET FITTED;
- Do not twist or bend the fused quartz bulb when fitting the lamp as mechanical stresses MUST be avoided;
- Ensure that the spring contacts firmly surround the pins on the cap of the lamp. Do not apply unnecessary force when tightening the screws;
- After inserting the lamp, ensure that there is sufficient axial play in the lampholder. The lamp must be capable of unimpeded expansion when it warms up to operating temperature. Mechanical forces must not be applied to the fused quartz bulb;
- Electrical leads must be arranged in such a way that there is a sufficient air gap (approximately 40mm) between them and the lamphouse, in order to prevent flashovers from the ignition voltage. All flexible leads must have strain-relieving clamps;
- Before putting the lamp into service for the first time, check the polarity of the electrical connections. INCORRECT POLARITY WILL CAUSE IMMEDIATE DESTRUCTION OF THE LAMP;
- Before the protective jacket is removed, suitable protection must be worn i.e. face mask and gloves with wrist protection;
- Never touch the quartz bulb with bare hands, as fingerprints will make the glass cloudy and cause a severe loss of light. This may also cause recrystallisation and thus weaken the bulb material. Should the bulb be inadvertently touched, remove fingerprints with methylated spirit and a clean, soft paper towel. The bulb should then be wiped with distilled water. (NOTE: ALWAYS WEAR MASK AND GLOVES DURING CLEANING);
- All packaging and the protective jacket must be retained for re-use. Whenever removing a lamp, the protective jacket must always be used for safety reasons;

## Notes:

- 1) XBO lamps are designed for dc operation only. The dc current may only be varied within the limits of the current control range. An XBO lamp operates best at rated current; over the life of the lamp, the current may be increased to its maximum value to compensate for loss of light. The output of the lamp can be reduced by operating the lamp at minimum current but this does not prolong the life of the lamp;
- 2) For safety reasons, XBO lamps should be replaced once they reach the end of their average lamp life, and not later than 1.25 times their average lamp life. After this time there is an increased risk of the lamp exploding;
- 3) The anode (positive cap marked '+') must be on top when the lamp is inserted in the vertical position. If the anode is incorrectly inserted the arc will be unstable, the bulb will blacken more quickly and the lamp will prematurely fail;
- 4) The HT lead from the high voltage terminal of the ignitor, must be connected to the cathode (negative cap marked '-'). If the lamp is connected with the wrong polarity it will be irreparably damaged after a very short time.
- 5) In all circumstances the lamp manufacturers data should be referred to when dealing with lamps.

## 7- Fault Finding

All fault finding must be conducted by a competent person or qualified Electrical Engineer.

Please refer to the following table for the trouble-shooting of Xenon lamps.

Fault	Cause	Remedy
<ul style="list-style-type: none"> <li>■ Wrong Polarity</li> </ul>	<ul style="list-style-type: none"> <li>■ Lamp incorrectly fitted</li> <li>■ Faulty wiring</li> </ul>	<ul style="list-style-type: none"> <li>■ Anode (large electrode) must always be on top in vertical burning position</li> <li>■ Check polarity, transpose connections if necessary</li> </ul>
<ul style="list-style-type: none"> <li>■ Cap overheated</li> <li>■ Cap temperature above 230°C</li> </ul>	<ul style="list-style-type: none"> <li>■ Faulty contacts</li> <li>■ Cooling equipment defective</li> </ul>	<ul style="list-style-type: none"> <li>■ Check terminals, tighten or renew</li> <li>■ Check cooling equipment and replace if necessary</li> </ul>
<ul style="list-style-type: none"> <li>■ Arc unsteady</li> </ul>	<ul style="list-style-type: none"> <li>■ Lamp operated outside current control range</li> <li>■ Magnetic stabilisation for horizontal operation defective</li> </ul>	<ul style="list-style-type: none"> <li>■ Correct current setting</li> <li>■ Check magnetic stabilisation</li> </ul>
<ul style="list-style-type: none"> <li>■ Bulb draws in air</li> </ul>	<ul style="list-style-type: none"> <li>■ Crack in graded seal caused by overheated cap</li> <li>■ Maximum cap temperature 230°C</li> </ul>	<ul style="list-style-type: none"> <li>■ Check terminals - tighten or renew</li> </ul>
<ul style="list-style-type: none"> <li>■ Glass erosion on fused quartz bulb</li> </ul>	<ul style="list-style-type: none"> <li>■ Lamp operated outside current control range</li> <li>■ Lamp service life exceeded</li> </ul>	<ul style="list-style-type: none"> <li>■ Correct current setting</li> <li>■ Check meter</li> </ul>
<ul style="list-style-type: none"> <li>■ Electrodes damaged</li> <li>■ Premature blackening</li> </ul>	<ul style="list-style-type: none"> <li>■ Current ripple too high</li> <li>■ Auxiliary mirror incorrectly adjusted</li> </ul>	<ul style="list-style-type: none"> <li>■ Have power supply inspected</li> <li>■ Adjust auxiliary mirror</li> </ul>
<ul style="list-style-type: none"> <li>■ Asymmetrical blackening of lamp (in horizontal burning position)</li> </ul>	<ul style="list-style-type: none"> <li>■ Lamp operated too long in same position</li> </ul>	<ul style="list-style-type: none"> <li>■ Turn lamp through 180° after half service life</li> </ul>

## Failure of Lamp to Ignite

In the event of the xenon lamp failing to light the following steps should be taken:

- 1) Check that the mains supply is connected to the input of the PSU. On operating the switch, if the lamp does not light switch off mains supply and check all fuses;
- 2) On pressing remote starting switch the lamp still does not ignite, check the searchlight head. On your command get an operator to activate the starting switch for approximately 10 seconds. During this time listen for any noise (cracking or hissing) coming from within the barrel. If this arcing is heard switch off the supply at the mains. Remove the rear dome to expose the two supply leads to the xenon lamp. Using a dry cloth wipe these leads to remove any dust, moisture or condensation that may have formed around the inside of the barrel. Replace the rear dome, ensuring the swing bolts are securely tightened, and perform the check again, listening for the cracking. If the lamp still fails to ignite, switch off at the mains and replace the xenon lamp in accordance with the safety procedures within this manual and the manufacturers' information.

**Any further tests to be carried out with regards to lamp failure must be conducted by a competent electrical engineer and should not be carried out in an explosive atmosphere.**

- 3) Before a xenon lamp will ignite, the electrically insulated gas between the electrodes must be ionised. This is done by the ignitor which produces a high frequency voltage (up to 30,000 volts or higher). The ignitor is activated by switching the lamp on and a crackling or hissing noise should be heard. The ignitor is housed within the rear of the searchlight barrel. This is a totally encapsulated unit and repair is not advised. If found to be faulty a new ignitor must be fitted.

## 8 - Maintenance and Servicing

In order to prolong the service life and performance of your searchlight, the following maintenance guidelines are recommended:

- Maintenance checks should be conducted before every voyage or at least every three months;
- Before checking, disconnect the equipment from the supply;
- Visually inspect the condition of the equipment;
- Any major or minor structural damage should be rectified immediately in order to reduce sympathetic wear;
- After inspection it may be necessary to clean the inside of the searchlight. The following procedure should be adhered to:
  - Remove the front bezel;
  - Clean the front glass inside and out using a proprietary glass cleaner or metal polish;
  - Clean the reflector if required;
  - Check the reflector mounting gaskets. If signs of corrosion or damage are evident, replace as necessary;
  - Ensure that the lampholder is free from corrosion or other damage;
  - Check earthing point for conductivity;
- It is advisable to check all seals and gaskets for signs of degradation. Renew if necessary;
- Upon completing all maintenance requirements the searchlight should be tested for full working order (approximately 20 minutes).
- Every six months the external movement mechanisms i.e. lockwheels, elevation and pan mechanisms, should be lightly lubricated.

**If in any doubt as to the correct servicing procedures to adopt please contact your distributor/agent or the manufacturer who will be able to advise the best course of action for your product.**

## 9 - Wiring Diagram & General Assembly Drawings

Drawing Number	Description
X4737	Xenon Wiring Diagram
X4719	FX380 Deck General Assembly
X4720	FX380 Deck Pedestal General Assembly
X4721	FX380 Cabin General Assembly
X4722	FX380 Cabin Pedestal General Assembly



FIRST USED ON  
FX380D

DO NOT SCALE DRAWING (569)

THIRD ANGLE PROJ

50mm  
0 10 20 30 40

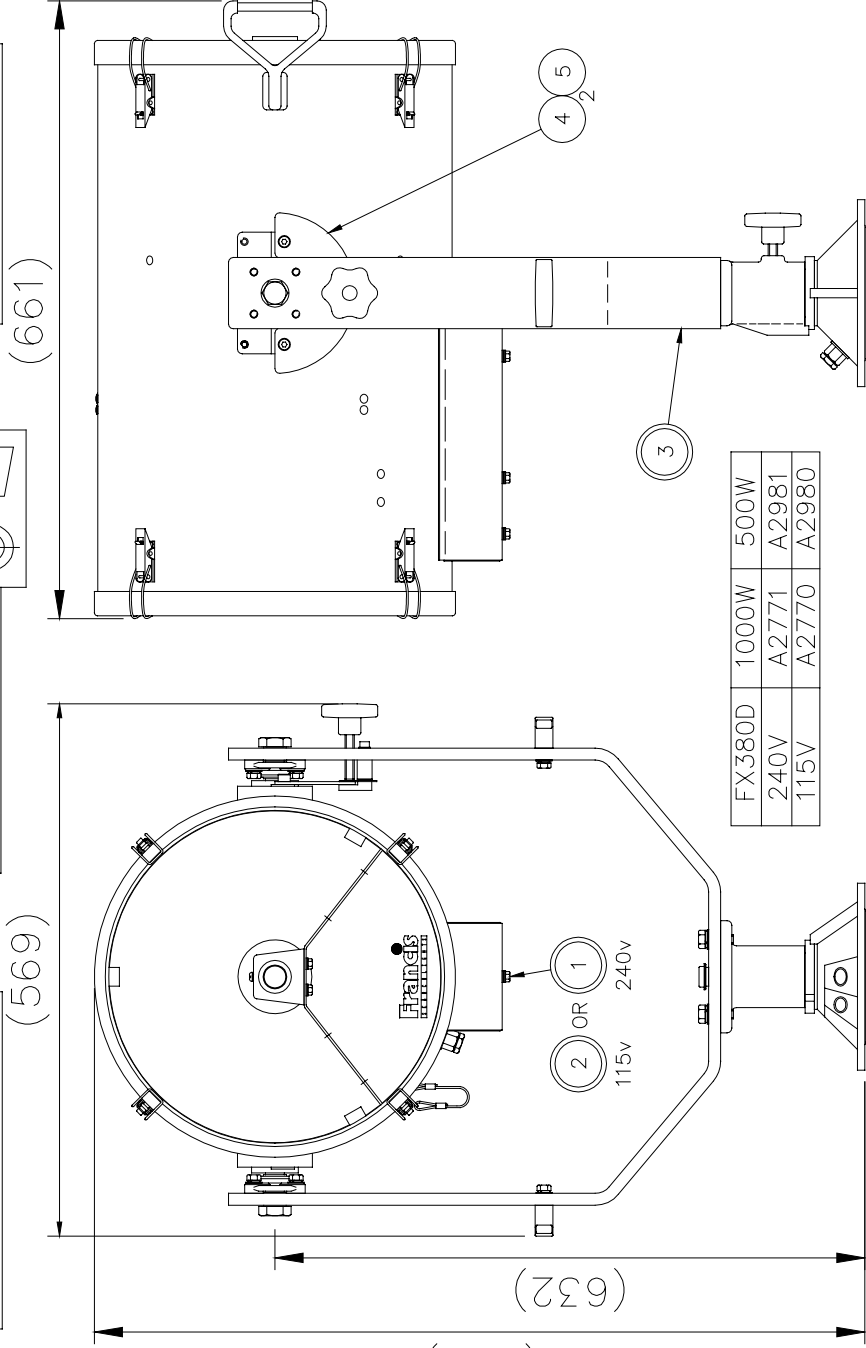

FX380D	1000W	500W
240V	A2771	A2981
115V	A2770	A2980

ITEM	PART No.	DRG No.	DESCRIPTION	QTY	ITEM	PART No.	DRG No.	DESCRIPTION	QTY
1	C16927	X4715	BARREL ASSY 240v	1	4	C11380	X2863	QUADRANT	1
2	C16934	X4715	BARREL ASSY 115v	1	5	C11182		M8 x 16 SKT CAP HD SCREW	2
3	C16940	X4729	DECK MOUNT	1					

ISS No	MODIFICATION DETAILS	DATE & INITS
1	AS FIRST DRAWN	6.97 D.S.
2	500W VERSIONS ADDED. (EC0724)	1.99 TJC
3	BROUGHT IN-LINE WITH DETAIL (EC0844)	10.00 D.S.
4	RE-DESIGNED TO USE RC CRUTCH (EC0874)	1.01 D.S.
5	BROUGHT IN-LINE WITH DETAIL (EC0998)	3.02 M.T
6	BARREL LATCHES (EC1020)	2.03 D.S.

STANDARD PRACTICE  
Deburr all cut/machined edges  
Break corners R0.25(Max) U.O.S.  
TOLERANCES U.O.S. -  
General: ±  
Angular: ±  
Hole centres & posns: ±  
Sand Casting: To ISO 8062 CT10  
Die Casting: To ISO 8062 C18



FRANCIS SEARCHLIGHTS LIMITED, UNION ROAD, BOLTON, BL2 2HJ © 1997 A3 CONT ON SHEET

DRAWN	D.S.	DATE	9.6.97	MATERIAL
CHECKED		SCALE	1:5	
ALL DIMENSIONS IN MILLIMETRES				

DESCRIPTION	FX380D G.A.
PART No./DRG No.	

SHT	1
-----	---

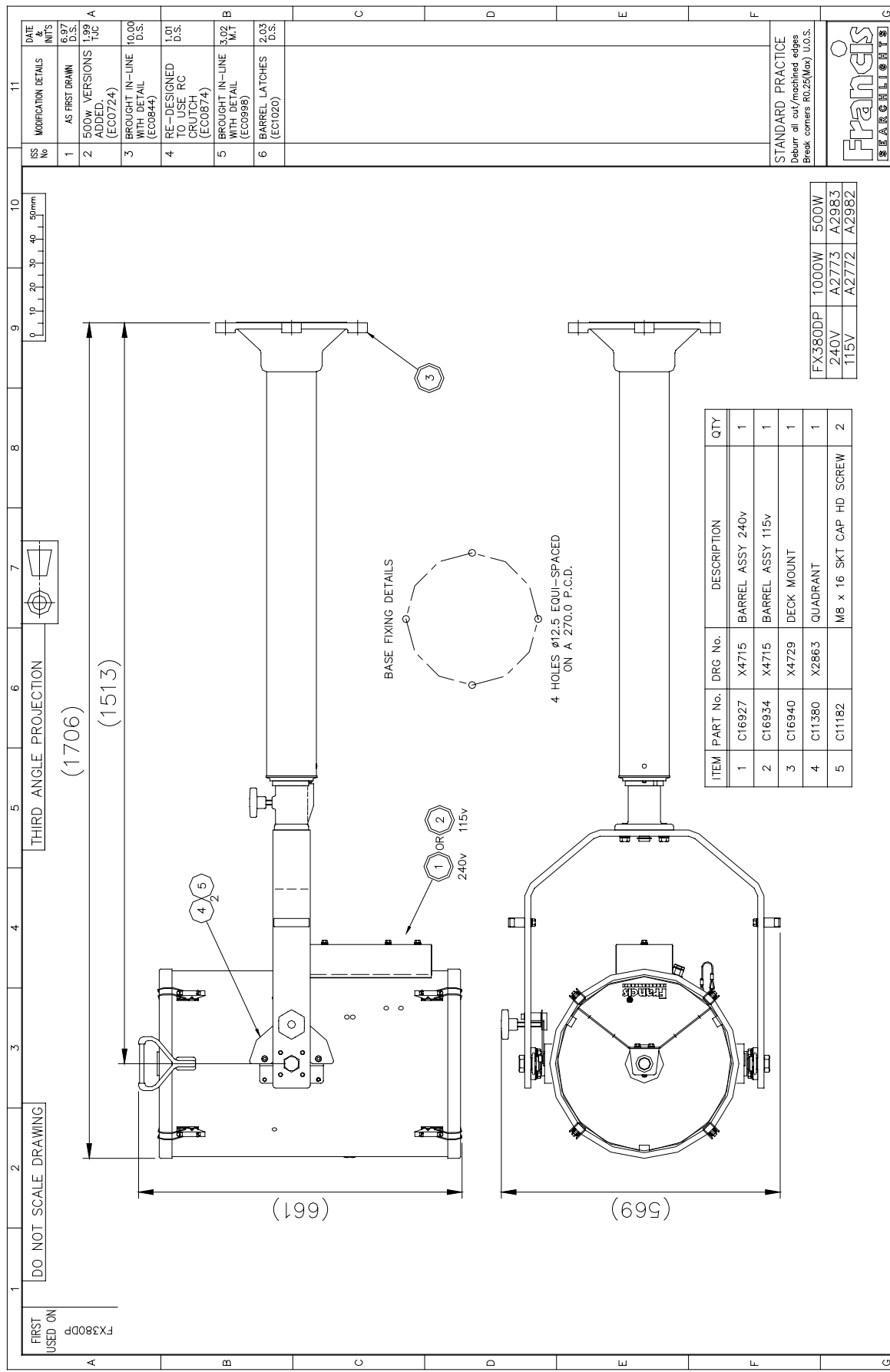

ISS No	MODIFICATION DETAILS	DATE INITS
1	AS FIRST DRAWN	6.97 D.S.
2	500w VERSIONS ADDED. (EC0724)	1.99 TJC A
3	BROUGHT IN-LINE WITH DETAIL (EC0844)	10.00 D.S.
4	RE-DESIGNED TO USE RC CRUTCH (EC0874)	1.01 D.S.
5	BROUGHT IN-LINE WITH DETAIL (EC0996)	3.02 M.T
6	BARREL LATCHES (EC1020)	2.03 D.S.

ITEM	PART No.	DRG No.	DESCRIPTION	QTY
1	C16927	X4715	BARREL ASSY 240v	1
2	C16934	X4715	BARREL ASSY 115v	1
3	C16940	X4729	DECK MOUNT	1
4	C11380	X2863	QUADRANT	1
5	C11182		M8 x 16 SKT CAP HD SCREW	2

FX380DP	1000W	500W
240V	A2773	A2983
115V	A2772	A2982

STANDARD PRACTICE  
Debur all cut/machined edges.  
Break corners R0.25(Max) U.O.S.

© 1997 A2 CONT ON SHEET  
PART No./DRG No. X4720 1  
SHT 1

FRANCIS SEARCHLIGHTS

DO NOT SCALE DRAWING  
THIRD ANGLE PROJECTION  
FIRST USED ON FX380DP

DRAWN D.S. DATE 6.97 TOLERANCES  
CHECKED SCALE 1:5  
ALL DIMENSIONS IN MILLIMETRES  
Sand Casting: To ISO 8062 CT10 MATERIAL  
Die Casting: To ISO 8062 CT8  
Hole centres & posns: ±  
Cenrpt: ±  
Anglur: ±

FRANCIS SEARCHLIGHTS LIMITED · UNION ROAD · BOLTON · BL2 2HJ  
DESCRIPTION  
FX380DP G.A.

ISS No	MODIFICATION DETAILS	DATE D.S.	INTS
1	AS FIRST DRAWN	6.97	D.S.
2	500W VERSIONS ADDED. (EC0724)	1.99	TJC
3	BROUGHT IN-LINE WITH DETAIL (EC0844)	10.00	D.S.
4	RE-DESIGNED TO USE RC CRUTCH (EC0874)	1.01	D.S.
5	BROUGHT IN-LINE WITH DETAIL (EC0998)	3.02	M/T
6	BARREL LATCHES (EC1020)	2.03	D.S.

ITEM	PART No.	DRG No.	DESCRIPTION	QTY
1	C16927	X4715	BARREL ASSY 240v	1
2	C16934	X4715	BARREL ASSY 115v	1
3	C16938	X4726	TRAINER MOUNT	1

FX380C	1000W	500W
240v	A2775	A2985
115v	A2774	A2984

STANDARD PRACTICE  
 Debur all cut/machined edges  
 Break corners R0.22(M6) U.O.S.

FRANCIS SEARCHLIGHTS LIMITED . UNION ROAD . BOLTON . BL2 2HJ

© 1997 A2 CONT ON SHEET

Part No./DRG No. X4721 1

FX380C G.A.

Drawn D.S. DATE 6.97 TOLERANCES To ISO 8062 CT10 MATERIAL  
 Checked SCALE 1:5 General: ±  
 ALL DIMENSIONS IN MILLIMETRES Angular: ±

3 HOLES ø11.0  
 EQUI-SPACED ON  
 A 174.0 P.C.D.

HOLE ø40.0

BASE FIXING DETAILS

THIRD ANGLE PROJECTION

DO NOT SCALE DRAWING

FIRST USED ON FX380C



DRAWN	D.S.	DATE	6.97	TOLERANCES	To ISO 8062 CT10	MATERIAL
CHECKED	SCALE	1:5	General: ±	Angular: ±		
ALL DIMENSIONS IN MILLIMETRES						

FRANCIS SEARCHLIGHTS LIMITED . UNION ROAD . BOLTON . BL2 2HJ

© 1997 A2 CONT ON SHEET

Part No./DRG No. X4721 1

FX380C G.A.

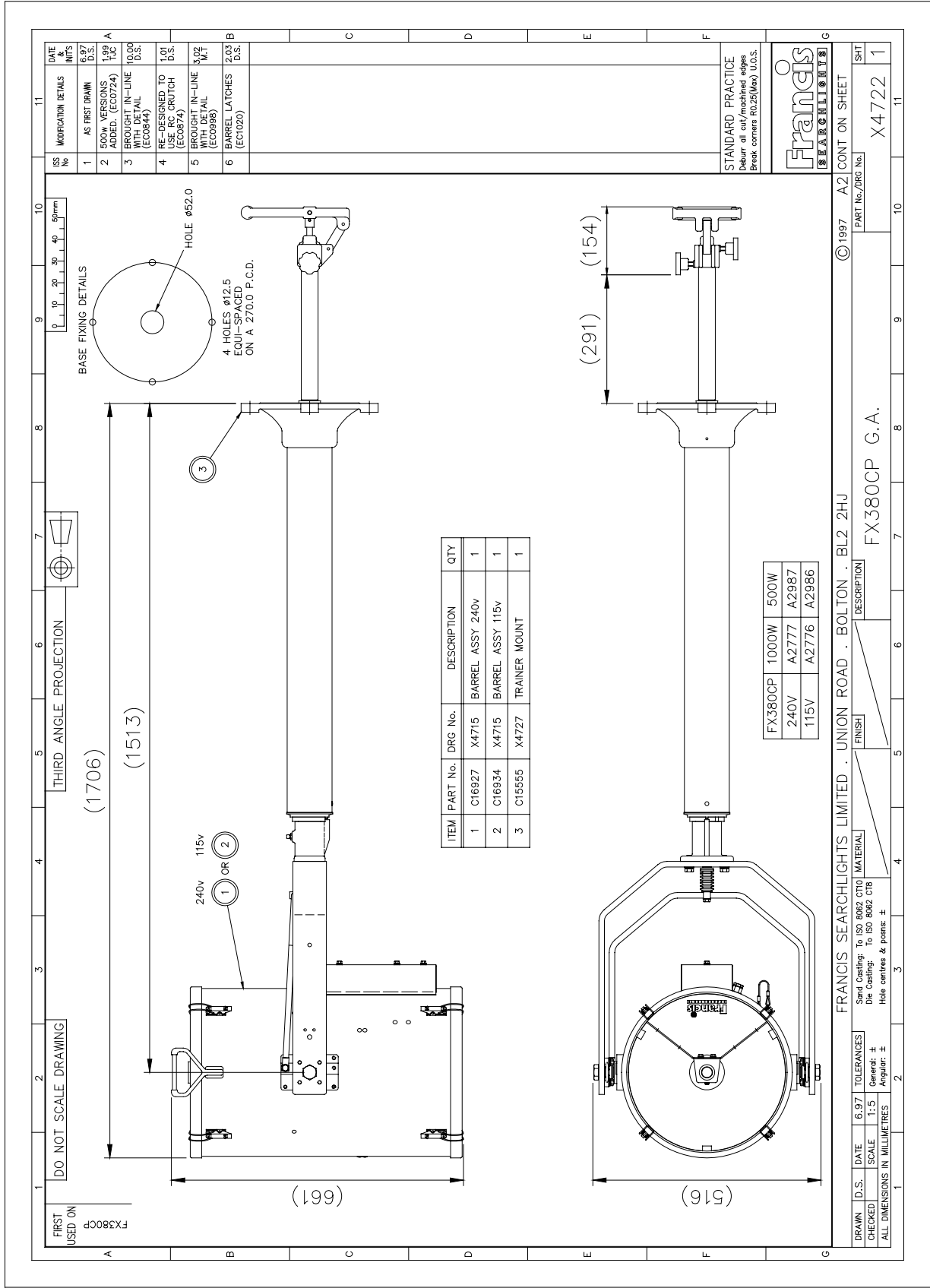

ISS No	MODIFICATION DETAILS	DATE & INTS
1	AS FIRST DRAWN	6.97 D.S.
2	500W VERSIONS ADDED. (EC0724)	1.99 D.S.
3	BROUGHT IN-LINE WITH TAIL (EC0844)	10.00 D.S.
4	USE DESIGNATED TO USE AS SHOWN (EC0874)	1.01 D.S.
5	BROUGHT IN-LINE WITH DETAIL (EC0988)	1.07 D.S.
6	BARREL LATCHES (EC1020)	2.03 D.S.

STANDARD PRACTICE  
 Debur all cut/machined edges  
 Break corners R0.25(Max) U.O.S.

**Francis**  
 FRANCIS SEARCHLIGHTS LIMITED

© 1997 A2 CONT ON SHEET  
 PART No./DRG No. X4722  
 SHT 1

ITEM	PART No.	DRG No.	DESCRIPTION	QTY
1	C16927	X4715	BARREL ASSY 240v	1
2	C16934	X4715	BARREL ASSY 115v	1
3	C15555	X4727	TRAINER MOUNT	1

FINISH	DESCRIPTION
FX380CP	1000W 500W
240V	A2777 A2987
115V	A2776 A2986

FRANCIS SEARCHLIGHTS LIMITED · UNION ROAD · BOLTON · BL2 2HJ

DRAWN	D.S.	DATE	6.97	TOLERANCES
CHECKED <td></td> <td>SCALE</td> <td>1:5</td> <td>General: ± Finish: ±</td>		SCALE	1:5	General: ± Finish: ±

MATERIAL	FINISH	DESCRIPTION
To ISO 9002 C18 To ISO 9002 C18		FX380CP G.A.

ALL DIMENSIONS IN MILLIMETRES

11  
10  
9  
8  
7  
6  
5  
4  
3  
2  
1

## 10 - Spare Parts List

The following spare parts can be ordered directly from the manufacturer:

Part Number	Description
C13503-00	Power supply unit (240v)
C15326-00	Power supply unit (115V)
C12081-00	Ignitor (240V)
C12080-00	Ignitor (115V)
C16930-00	Fan (240V)
C16931-00	Fan (115V)
D21229	Lamp
C08919-00	Front glass
C22011-00	Front glass gasket
C23277-01	Heater & Fuse Assembly
C06020-00	Reflector
C21502-01	Base lockwheel assembly
C21503-01	Side lockwheel assembly
C11148-00	'O' ring seal (Deck & Cabin)
C10170-00	'O' ring seal (Deck Ped & Cabin Ped)
C20281-00	Bellows
C08926-00	Seal
C13544-37	Cathode (-ve) adaptor

In order to prolong the life and performance of your product, we recommend that you only specify Francis Searchlights spare parts. This will ensure that any warranties on your equipment will not be invalidated.

When ordering spare parts please contact the Sales Department at Francis Searchlights Limited. Please quote searchlight model and serial number at all times. This will enable a fast response to your spares requirements