



User Instruction & Installation Manual

Polaris 7Kw Xenon Searchlight



Product Reference Number:

A2434 – Polaris 7Kw

Manufacturers details:

Francis Searchlights Ltd
Union Road, Bolton
Lancashire, BL2 2HJ, UK
Tel: +44 (0) 1204 558960
Fax: +44 (0) 1204 558979
<http://www.francis.co.uk>
E-mail: sales@francis.co.uk

Distributor details:

Manual Part Number: C15144

Issue: 2

CONTENTS

- 1 - Introduction
- 2 - Safety Precautions
- 3 - Technical Information
- 4 - Removal and fitting of the lamp
- 5 - Testing
- 6 - Fault Finding
- 7 - Wiring Diagrams
- 8 - Spare Parts List

1 – Introduction

It is imperative that this manual is read carefully and understood before installing your equipment. For your future reference please keep this manual in a safe place.

Thank you for specifying a product from the Francis Searchlights range. The Francis Polaris xenon searchlight utilises “state of the art” optical technology based on the many years’ experience of Francis in the design and manufacture of searchlights and specialised lighting. The end result is a luminaire, which produces an extremely powerful and precise shaft of light, which under reasonable conditions can be observed from many miles away.

In order to prolong the life and performance of your product, we recommend that you only specify Francis Searchlights spare parts. This will also ensure that any warranties on your equipment will not be invalidated. Information on spares ordering and parts is provided in this manual.

Should you ever need to contact Francis Searchlights Ltd. regarding your equipment, please quote the Product Serial Number at all times.

2 – Safety Precautions

The following instructions must be adhered to, in order to ensure a safe working environment and the safety of the user.

Note: When unpacking or manoeuvring the searchlight into its fixing position, suitable lifting points must be used in order to prevent damage to the equipment or personal injury.

- Because of the high internal pressure within the lamp, there is a risk of explosion in either a hot or cold state;
- During operation this lamp emits intense UV radiation which is harmful to the eyes and skin. Suitable protection should be worn;
- The high luminance of the arc can cause severe damage to the eye if viewed directly. ALWAYS wear suitable protective goggles when viewing the lamp;
- Always use protective jackets supplied with the lamp;
- Should it be necessary to examine the lamp with the front bezel removed, always use a protective shield and wear goggles to ensure a safe working environment;
- Searchlights get hot. Never touch the unit when lit and always allow 15 to 20 minutes for cooling down after turning the searchlight off;
- Never place anything on or cover the searchlight when in use;
- Ensure the lamp has cooled sufficiently before removal;
- If undue force appears necessary to remove the lamp, the equipment should be inspected by a competent person or contact the manufacturer;
- When disposing of lamps there are several options available:
 - Return the lamp, via the supplier, to the lamp manufacturer in its complete packaging
 - Because of the cold internal pressure of the lamp is approximately 8 bar, the lamp must first be depressurized before disposal. Place the lamp, in its protective jacket, in a plastic bag and drop from a height of 1 to 2 metres onto a hard surface;
- XBO lamps do not contain materials which are harmful to the environment and thus are not subject to special waste disposal regulations;
- Due to the vast range of lamps available it may appear possible that more powerful lamps can be used in the equipment than for which it was designed. Even when the unit will physically accept a higher wattage lamp, this substitution is not recommended and is dangerous. This action will also void any warranties on the equipment.
- Always refer to the lamp manufacturers technical data when dealing with lamps.

3 – Technical Information

This product has been designed to operate in accordance with the product specification. The Polaris 7000 watt searchlight has the following features:

- All marine grade materials and fixings;
- Electronic power supply unit;
- Electro-formed rhodium coated nickel reflector;
- Forced air-cooling of the lamp chamber utilising high-power fans and ducting;
- Instant lamp strike and re-strike (no warm-up period);
- Enclosure protection to IP56;
- Stove enamel painted;
- 360° horizontal rotation;

The searchlight also performs to the following optical data:

- Xenon light source;
- Lamp life 500 hours;
- Lamp Wattage – 7000 Watts;
- Supply voltage – 380/415v 3 phase plus neutral;
- Peak Beam Candlepower – 10⁹;
- Range – 10 Lux at 10 Km;
- Divergence – 1.5° to 10° incl.;

In order that the searchlight operates correctly it is imperative that competent personnel are responsible for the installation, operation and servicing of this equipment. Failure to adhere to this advice may cause premature failure or incorrect operation of the searchlight, which may damage the equipment or cause personal injury.

Technical information on the Xelamp Power Supply Unit and Irem Ignitor are included overleaf. For more detailed information please contact the manufacturer.

PSU ref: Model 8537 (Xelamp)
Ignitor ref: AS16040A (Irem)

Power Supply Details (Model 8537)

General Description

| | | |
|--------------------|-----------|--------------------|
| Output | Power | 5000-7000 watts |
| | Voltage | 40-50 volts DC |
| | Current | 120-180 amp |
| | Ripple | 5% peak-to-peak |
| Input | Current | 20 amperes maximum |
| | Voltage | 380/415 volts AC |
| | Phase | 3 phase |
| | Frequency | 50 Hz |
| Output Adjustments | | 16 steps |
| Size | Width | 19.5" (50 cm) |
| | Height | 15.5" (40 cm) |
| | Length | 14" (36 cm) |
| Weight | | 170 lbs. (77 Kg) |
| Cooling | | Internal blower |

Warning

When this appears in this text, it indicates a hazard to personnel.

Caution

When this appears in this text, it indicates a procedure, which can result in equipment damage if not properly accomplished.

Receiving the Power supply

The units are shipped with the power supply bolted to a shipping skid and enclosed in a heavy cardboard cover held in place by banding. Physical damage to the container or its contents should be reported to the carrier immediately.

Unpacking

Cut the banding strips and lift the cardboard cover off of the unit. Remove the four bolts holding the power supply to the skid. Place the unit in the location selected for installation.

Locating the power supply

An internal blower cools the PSU so the location selected should provide a minimum of 6" clearance around the case. The area should have free movement of air to dissipate the heat generated by operation of the power supply. Provide a space large enough to allow service of the unit if required. Try to select a location as close to the searchlight as practical. Many users install

the power supply unit adjacent to the searchlight where space is available and local codes permit. The power supply must be positioned in a suitable dry location.

Caution

Do not allow anything to be placed upon the power supply case; the perforated top is for ventilation and must not be obstructed.

Electrical installation and connection

Caution

Much future grief can be avoided by having a competent electrical contractor install and connect this unit.

Caution

We make suggestions in this manual as to minimum wire sizes to be used. Refer to, and conform to the codes applicable in your area.

Caution

Observe polarity of the conductors, which carry the D.C. output of the power supply to the searchlight. Reversed polarity will immediately destroy the xenon bulb upon application of power.

Warning

When the electrical installation is complete, there are two sources of primary power within the unit. Turn off all power when adjusting or servicing the power supply.

Warning

This unit can run warm to very hot. Allow at least 15 minutes after turning off the power for the unit and its components to cool down before attempting any service procedures.

Holes are provided in the end section of the power supply case for conduit entries. Install conduit in a manner, which allows some movement for service if required. Refer to drawings for connection information.

Model 8537 Primary power: #10 gauge minimum;
 Circuit protection: 30 ampere breaker or fuses.
 D.C. output: #1 gauge minimum.

Warning

The power supply has two sources of power. Disconnect (turn off) primary power before making adjustments or performing service procedures.

Warning

The power supply stores energy in the capacitor bank after the primary power is switched off. Wait a minimum of two minutes after power is switched off for the capacitor charge to bleed off.

Warning

This unit can run warm to very hot. Allow at least 15 minutes after turning off the power for the unit to cool down before attempting any service procedure.

Output power adjustment

Taps are provided on TB1, TB2 and TB3 for coarse adjustment of the output current.

TB1, TB2 and TB3 each have four taps marked W-X-Y-Z. Tap W provides the lowest output current; Tap Z provides the highest.

Moving the orange coloured wire on each terminal block changes taps. All three terminal blocks must have the orange wire in the same tap position, i.e. TB1-W, TB2-W & TB3-W.

Taps are provided on TB4, TB5 and TB6 for fine adjustment of the output current.

Each of the three terminal blocks TB4, TB5 and TB6 has four taps marked 1-2-3-4. Tap 1 provides the lowest output current; tap 4 provides the highest.

Moving the black coloured wire on each terminal block changes taps. All three terminal blocks must have the black wire in the same tap position, i.e. TB4-2, TB5-2 & TB6-2.

In changing taps, do not insert the tap lead into the connector so far as to clamp on the insulation rather than the bare wire.

Be sure all connector screws have been tightened.

Routine maintenance

Warning

The power supply has two sources of power. Turn off primary power before servicing the unit.

The unit and its components run warm or even hot. Service is best accomplished before the day's run.

At 6 month intervals, remove all accumulated dust and dirt from the power supply.

Clean and re-tighten any electrical connection which has discoloured due to overheating.

Make certain all connections are secure.

Troubleshooting

Warning

Some of the trouble shooting procedures described in the following text requires a power "ON" condition.

The primary line voltage is hazardous and extreme caution should be taken to avoid electrical shock.

Much data can be obtained from the volt ammeter built into the lamphouse. In addition, the following instruments will be needed to perform all trouble-shooting operations that can be done in the field:

Portable volt-Ohm-ammeter (VOM) – must be capable of supplying sufficient current to forward bias a silicon diode on R X 1 range. (Some digital instruments cannot; consult operator's manual for instrument concerned.)

Clamp-on A.C. ammeter capable of ¼ ampere or better resolution.

Xenon lamp power supplies have two stages of operation:

- 1) Before igniting the bulb – At this time, the voltage at the power supply output terminals reaches "open circuit" value (110 VDC or greater).
- 2) After lamp ignition – At this time, the load placed on the power supply by the xenon lamp (40-48 VDC) determines the voltage at the power supply output terminals.

Power supply difficulties can be separated into one of four areas for purposes of diagnosis and repair:

- A) Power line problems.
- B) Boost circuit (Open circuit voltage) problems.
- C) Control Circuits.
- D) Main power supply problems.

A) Primary power problems

Primary power problems are most commonly a complete absence of power, or single phasing in which one phase delivers no power.

In either case the system will be inoperative.

Use a VOM to measure the primary line voltage and determine the point of failure.

When power is lost on one phase or phase voltages are not the same, the ripple current will increase and cause CB1 on the power supply chassis to trip. When CB1 trips, K1 is disabled, removing primary power to the power supply.

Capacitors c8 through c10 increase the power factor from about 0.5 to 0.8. This results in lower input current per phase. Should one of these capacitors fail, the input currents will differ. This may cause voltage unbalancing and consequently higher ripple.

B) Boost circuit problems (open circuit voltage)

Loss of the open circuit voltage due to boost circuit problems will result in the following:

Ignitor will not fire in the AUTO mode.
Lamp may not ignite in the manual mode.

Disable the ignitor by removing the primary power to the ignitor. Energise the power supply. Observe the voltmeter on the lamphouse operating panel. If you have 110 VDC or more, the boost circuit is operating.

If the DC is voltage low, on the order of 50-60 volts, the boost circuit is inoperative. Check R1, CR7 and CR8.

C) Control Circuits

Contactor K1 applies primary power to the power supply.

K1 is energised by either an automation system or by a manually operated switch.

When connections to TB7 are made as indicated, there are two protective devices in series with the coil of K1: CB1 and TS1.

CB1 will trip in the presence of high ripple due to failure of one leg of the primary power or by rectification or filter problems.

TS1, which is a thermal switch mounted on one of the power supply heatsinks, will trip if there is excessive heat. The cause may be lack of adequate ventilation, a defective diode, or excessive load current.

Any interruption of the control circuit will disable K1 and no primary power will reach the power supply.

I Main power supply problems

Rectification is by diodes CR1-6.

A shorted diode will trip CB1 and will trip the sub-panel breaker feeding the power supply.

An open diode will cause a pronounced flicker in the projected light. CB1 should trip due to high ripple current. The sub-panel breaker feeding the power supply may trip.

Capacitor bank C1-C2 provides filtering of the rectified DC and stores enough energy in the pre-ignition portion of the cycle to insure good ignition characteristics.

A shorted C1 or C2 will trip CB1.

An open or deteriorated C1 or C2 will cause erratic ignition and a higher than normal screen flicker.

High ripple will cause CB1 to trip, shutting down the system.

K2, in the presence of high open circuit voltage, will energise placing R2 in series with the capacitor bank C1-C2. This limits the in-rush surge current and prolongs discharge of C1-C2 long enough to insure reliable ignition.

If K2 does not function, ignition may become erratic, and if R2 remains in the circuit, ripple will increase. It will probably not increase enough to trip CB1, but will cause observable flicker in the projected light.

Diode testing and replacement

To test a diode it must be disconnected from the circuit in which it is used.

In many failure modes, the diode failure can be tentatively identified by discoloration of the bright surface because of excessive heat. You will still have to disconnect the diode and make further checks to verify failure.

After disconnecting the diode, use your VOM on the R x 1 scale. With the meter leads connected in one direction, the reading should be zero or close to it; reversing the meter leads, the indication should be a very high resistance. If the diodes do not exhibit these characteristics, replace it.

If you have removed a diode from its heatsink, or you are installing a new diode, observe the following instructions:

Clean the area of the heatsink in which the diode is to be installed.

Warning

You must use heatsink compound. It is caustic in nature. Do not use for fingers; keep it away from your eyes; and do not ingest. Follow instructions on the container in which the compound is packaged.

You may obtain heatsink compound at your local electronics dealer.

Apply the compound with a wood or plastic spatula; a lollipop stick will work well. A thin layer of compound is adequate.

CR1 – CR3 are 1N3291R types

CR4 – CR6 are 1N3291 types

When tightening the diodes the torque should be 90in. – 125in. lbs. Max.

AS series

Introduction

These igniters are expressly designed to strike Xenon, Xenon-Mercury, Mercury, Metal Halide and similar arc lamps. They produce the high voltage, high frequency starting potential required to get the gas in the lamp to ionize and make the current flow possible.

The **AS** igniters meet the lamp manufacturers' recommendations to ensure immediate and correct ignition of the lamp when cold or in any cooling stage.

They should be installed close to the lamp (but thermally shielded from it); the high voltage lead must be as short as possible and carefully insulated to prevent corona loss and reduction of strike energy. The ambient temperature must not exceed 60°C.

Some models are equipped with a built-in special function relay allowing automatically cycled or timed ignition. Also this relay prevents the igniter from striking when the lamp is ON or if the no-load voltage to the lamp is not correct. As far as the insulation class, this device can be considered Cl. II (as per IEC 536), but it must be grounded for interference suppression.

Block diagram

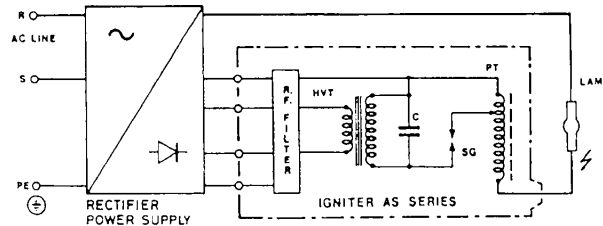

Outline drawing

AS-3040

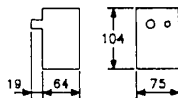

AS-8030

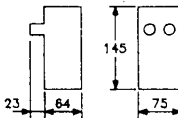

AS-16040/A

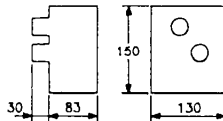

AS Series range

| Models | AC input (50-60Hz) | | H.V. output KV | Lamp current A | Weight Kg. |
|------------------|--------------------|-------------------|----------------|----------------|------------|
| | Volt | A during ignition | | | |
| AS-3040 | 230V | 0.8 | 40 | 30 | 1.3 |
| AS-8030 | ±10% | 1.5 | 30 | 80 | 1.5 |
| AS-16040A | | 3.8 | 40 | 160 | 3.5 |

The suffix 'A', used for the model AS-16040A, means that it has a built-in relay system for automatic or short timed ignition.

4 – Removal and fitting of the lamp

Isolate the equipment from its power supply.

Unfasten the five latches by depressing the safety latch.

Warning

Eye protection must be worn from this stage, an explosion hazard exists with xenon lamps they contain a high internal pressure, a faulty lamp can explode without warning.

Remove the bezel complete with its glass from the searchlight and put it in a safe place.

The spill ring assembly must now be removed, take note of the configuration of the three sets of fixing screws and nuts, remove the fixings and withdraw the spill rings.

Observe the configuration of the lampholder support spokes where they fit to the rod end bearings, disconnect one spoke only from the outer fixing and leave hanging.

Disconnect the lamp supply cable from the conductor assembly using two 13mm AF spanners, take note of the position of the washers etc. Inspect the conducting surfaces for cleanliness and corrosion. A high current is carried by this connection.

Using a 13mm AF spanner loosen the bolt securing the top finned lampholder to the lamp at the same time supporting the lampholder with one hand. It is vital that no force is transferred through the lamp. Gently pull the lampholder clear of the lamp and allow it to hang clear of the lamp.

Support the top of the lamp with one hand and release the bottom grub screw, which can be seen a little below the reflector. Again do not allow force to be transmitted through the lamp. The lamp can now be gently withdrawn upwards and kept in a safe place.

Avoid touching the glass envelope of the lamp, it must be handled by its end caps only.

If the glass has been contaminated it may be cleaned using an alcohol spirit.

With the lamp removed, take the opportunity to check the condition of the reflector.

If it is considered that cleaning is required this may be done using cotton wool and a proprietary silver polish e.g. Silvo.

Avoid scratching the surface by regularly turning the cotton wool and applying more polish, use a light rotary motion and clean a small area at a time.

Do not over clean. Any method other than the above will permanently damage the reflector's surface.

Refitting of the lamp is the reverse of the above. Make sure that lamp is fully located in its holders and all fixings are firmly tightened. Remember the support spokes should all be on the same side of their rod end bearings and when fixed in place should have a loose feel to allow free focus movement of the lamp. Connect the lamp supply cable to its terminal and tighten firmly.

Refit the spill rings. Clean the front glass inside and out, refit the bezel and fasten the latches.

5 – Testing

Required Equipment

Have available the following:

Megohm meter
Avo type meter
Current clamp meter with DC range
General electrical fitters tool kit
Circuit drawings X3946, X3947 and X3938

Interconnection of major components

Refer to circuit drawings and connect searchlight to power supply unit. PSU to suitably isolated 380 volt 3 phase plus neutral supply. Do not apply power at this stage.

As the wiring is of a temporary nature, particular attention must be paid to the earth bonding of all pieces of equipment. Using the megohm meter check all components to a sound earth. A resistance of not less than one megohm must be measured.

Warning Plates

Check that the warning plates have been fitted in the appropriate locations.
Danger eye protection.
Warning Heater circuits.

Safety considerations

Double check that all electrical protection covers and cable insulations are intact

Be sure that any freestanding units are in a stable state and any trailing leads and cables are in a safe condition.

When carrying out tests and adjustments on this equipment great care must be taken. High voltages and temperatures are present. Particular care must be taken in the vicinity of the exposed lamp, an explosion hazard exists, and eye protection must be worn at all times.

Electrical Testing

- 1) Apply power to the equipment. Switch the miniature circuit breaker to on.
- 2) Depress the test button on the earth leakage current device to verify its function the press reset.
- 3) Check the input voltage at the PSU L1: L2: L3. Tested to neutral should read 230v AC + or – 5%. The reading across any 2 phases should show 380 to 410v AC.
- 4) Within the control panel, check the voltage N to L1, this should be 230v as above.

The Control Circuit

The function of the control circuit is to monitor and power the various functions of the searchlight.

The ignitor, as its title suggest, is required to initially start up the xenon lamp; its function is largely automatic and self contained. When is required, it generates 50,000 volts to be induced into the lamp supply conductor. To prevent damage to the ignitor in the event of an unrelated failure, the power supply to it is removed after a 15 second period.

When the searchlight is running two fans direct a high volume flow of air, drawn from the outside, onto the two lamp caps.

When the light is turned off the fans continue in there above function to ensure adequate cool down for 100 seconds, at which time one of them shut down. The lower one of the fans continues to run in an anti-condensation role. Two heaters totalling 180 watt and situated at the inlet port of the fan are switched into circuit. One of the heaters is in series with the fan causing it to run at half speed.

The effect is that a constant circulation of warm air is maintained for as long as the power is applied to the system, a pilot shows when the heating mode is on. Timer 2 removes power from the ignitor.

A pilot light 'power on' shows when the system is energised.

Check that the anti-condensation mode is now functioning correctly.

The running searchlight

Switch to 'Light On'. The lamp should ignite and assume full and constant light output without delay or 'Warm Up'.

Visually check that the two cooling fans are running. Using the Avo meter, recheck the measurements as previously described, there should be no appreciable 'voltage drop'.

With the meter in its DC range, check the voltage output from the PSU and then at the control panel. The reading should be in the range 40-50 volts; a drop of a few volts at the control panel is permissible.

Using the clamp meter, measure the amperage of the lamp supply, which should be in the region of 150 amps, multiply the voltage (at the control panel) by the amperes to arrive at a kilowatt figure. A nominal seven kilowatt should be the result. If an adjustment is required to the power output, refer to the power supply information in section 3.

I.E.

Always isolate before carrying out adjustments.

Follow the instructions for changing the transformer tapping.

Refit the protection covers and restore the power.

Light Performance

Adjust the focus knob to attain a near parallel beam. Check that the focus mechanism does not have excessive overrun. Adjust the stops as required.

An elliptical or double image beam can be corrected by axial reflector adjustment.

Check the effectiveness of the spill rings. Their function is to prevent direct radiation escaping forwards and sideways from the light source.

Look for rings or bands of light detracting from the beam.

Measurement of light output is not required with this equipment.

Special regard should be paid to the resistance to dust ingress, check then integrity of all seals, gaskets and filters.

Setting to Work

Safe service in use necessitates the strict observance of the following precautions.

- Any article fabricated from quartz or glass is inherently fragile and care should therefore be taken, at all times, when handling lamps;
- Eye protection must be worn when handling lamps that have been removed from their packaging materials. The protective jacket should not be removed from the lamp for safety reasons, as there is a remote possibility of the lamp shattering violently, especially if it is subjected to mechanical shock or vibration;
- Ensure that the power rating of the Xenon lamp to be fitted is suitable for the lamphouse and power supply equipment (rectifier);
- Always isolate the equipment from the supply before inserting a lamp;
- Before inserting the lamp ensure that all contacts are clean. Contacts must be renewed at the slightest sign of corrosion. Sanding or filing down corroded areas is not recommended as this will only make the conducting surface between the pin and lampholder smaller, thus causing the lamp to overheat;
- The inert gas (Xenon) used in XBO lamps is under a pressure of several bar even when the bulb is cold. FOR SAFETY REASONS THE LAMP MAY ONLY BE INSERTED INTO THE LAMPHOUSE WITH THE PROTECTIVE JACKET FITTED;
- Do not twist or bend the fused quartz bulb when fitting the lamp as mechanical stresses MUST be avoided;
- Ensure that the spring contacts firmly surround the pins on the cap of the lamp. Do not apply unnecessary force when tightening the screws;
- After inserting the lamp, ensure that there is sufficient axial play in the lampholder. The lamp must be capable of unimpeded expansion when it warms up to operating temperature. Mechanical forces must not be applied to the fused quartz bulb;
- Electrical leads must be arranged in such a way that there is a sufficient air gap (approximately 40mm) between them and the lamphouse, in order to prevent flashovers from the ignition voltage. All flexible leads must have strain-relieving clamps;
- Before putting the lamp into service for the first time, check the polarity of the electrical connections. INCORRECT POLARITY WILL CAUSE IMMEDIATE DESTRUCTION OF THE LAMP;
- Before the protective jacket is removed, suitable protection must be worn i.e face mask and gloves with wrist protection;
- Never touch the quartz bulb with bare hands, as fingerprints will make the glass cloudy and cause a severe loss of light. This may also cause recrystallisation and thus weaken the bulb material. Should the bulb be inadvertently touched, remove fingerprints with methylated spirit and a clean, soft paper towel. The bulb should then be wiped with distilled water. NOTE: ALWAYS WEAR MASK AND GLOVES DURING CLEANING);
- All packaging and the protective jacket must be retained for re-use. Whenever removing a lamp, the protective jacket must always be used for safety reasons;

Notes:

- 1) XBO lamps are designed for dc operation only. The dc current may only be varied within the limits of the current control range. An XBO lamp operates best at rated current; over the life of the lamp, the current may be increased to its maximum value to compensate for loss of light. The output of the lamp can be reduced by operating the lamp at minimum current but this does not prolong the life of the lamp;
- 2) For safety reasons, XBO lamps should be replaced once they reach the end of their average lamp life, and not later than 1.25 times their average lamp life. After this time there is an increased risk of the lamp exploding;
- 3) The anode (positive cap marked '+') must be on top when the lamp is inserted in the vertical position. If the anode is incorrectly inserted the arc will be unstable, the bulb will blacken more quickly and the lamp will prematurely fail;
- 4) The HT lead from the high voltage terminal of the ignitor, must be connected to the cathode (negative cap marked '-'). If the lamp is connected with the wrong polarity it will be irreparably damaged after a very short time.
- 5) In all circumstances the lamp manufacturers data should be referred to when dealing with lamps.

6- Fault Finding

All fault finding must be conducted by a competent person or qualified Electrical Engineer.

Please refer to the following table for the trouble-shooting of Xenon lamps.

| Fault | Cause | Remedy |
|--|--|--|
| <ul style="list-style-type: none"> ■ Wrong Polarity | <ul style="list-style-type: none"> ■ Lamp incorrectly fitted ■ Faulty wiring | <ul style="list-style-type: none"> ■ Anode (large electrode) must always be on top in vertical burning position ■ Check polarity, transpose connections if necessary |
| <ul style="list-style-type: none"> ■ Cap overheated ■ Cap temperature above 230°C | <ul style="list-style-type: none"> ■ Faulty contacts ■ Cooling equipment defective | <ul style="list-style-type: none"> ■ Check terminals, tighten or renew ■ Check cooling equipment and replace if necessary |
| <ul style="list-style-type: none"> ■ Arc unsteady | <ul style="list-style-type: none"> ■ Lamp operated outside current control range ■ Magnetic stabilisation for horizontal operation defective | <ul style="list-style-type: none"> ■ Correct current setting ■ Check magnetic stabilisation |
| <ul style="list-style-type: none"> ■ Bulb draws in air | <ul style="list-style-type: none"> ■ Crack in graded seal caused by overheated cap ■ Maximum cap temperature 230°C | <ul style="list-style-type: none"> ■ Check terminals - tighten or renew |
| <ul style="list-style-type: none"> ■ Glass erosion on fused quartz bulb | <ul style="list-style-type: none"> ■ Lamp operated outside current control range ■ Lamp service life exceeded | <ul style="list-style-type: none"> ■ Correct current setting ■ Check meter |
| <ul style="list-style-type: none"> ■ Electrodes damaged ■ Premature blackening | <ul style="list-style-type: none"> ■ Current ripple too high ■ Auxiliary mirror incorrectly adjusted | <ul style="list-style-type: none"> ■ Have power supply inspected ■ Adjust auxiliary mirror |
| <ul style="list-style-type: none"> ■ Asymmetrical blackening of lamp (in horizontal burning position) | <ul style="list-style-type: none"> ■ Lamp operated too long in same position | <ul style="list-style-type: none"> ■ Turn lamp through 180° after half service life |

Failure of Lamp to Ignite

In the event of the xenon lamp failing to light the following steps should be taken:

- 1) Check that the mains supply is connected to the input of the PSU. On operating the switch, if the lamp does not light, switch off mains supply and check all fuses;
- 2) On pressing remote starting switch the lamp still does not ignite, check the searchlight head. On your command get an operator to activate the starting switch for approximately 10 seconds. During this time listen for any noise (cracking or hissing) coming from within the barrel. If this arcing is heard switch off the supply at the mains. Remove the access panel to expose the two supply leads to the xenon lamp. Using a dry cloth wipe these leads to remove any dust, moisture or condensation that may have formed around the inside of the barrel. Replace the access panel, and perform the check again, listening for the cracking. If the lamp still fails to ignite, switch off at the mains and replace the xenon lamp in accordance with the safety procedures within this manual and the manufacturers information.

Any further tests to be carried out with regards to lamp failure must be conducted by a competent electrical engineer and should not be carried out in an explosive atmosphere.

- 3) Before a xenon lamp will ignite, the electrically insulated gas between the electrodes must be ionised. This is done by the ignitor which produces a high frequency voltage (up to 50,000 volts or higher). Switching the lamp on activates the ignitor and crackling or hissing noise should be heard. The ignitor is housed within the rear of the searchlight barrel. This is a totally encapsulated unit and repair is not advised. If found to be faulty a new ignitor must be fitted.

7 – Wiring Diagrams

| Drawing Number | Description |
|----------------|-------------------------|
| X3938 | Control Circuit |
| X3946 | Schematic Wiring |
| X3947 | PSU Wiring |
| C23209 | PSU Wiring (Connection) |

FIRST USED ON
A2434

DO NOT SCALE DRAWING

THIRD ANGLE

0 10 20 30 40 50mm

| ISSUE No | MODIFICATION DETAILS | DATE & INITIALS |
|----------|----------------------|-------------------|
| 1 | AS FIRST DRAWN | 16-6-92 g.d.o. |
| 2 | SENSE ADDED | 22-6-92 g.d.o. |

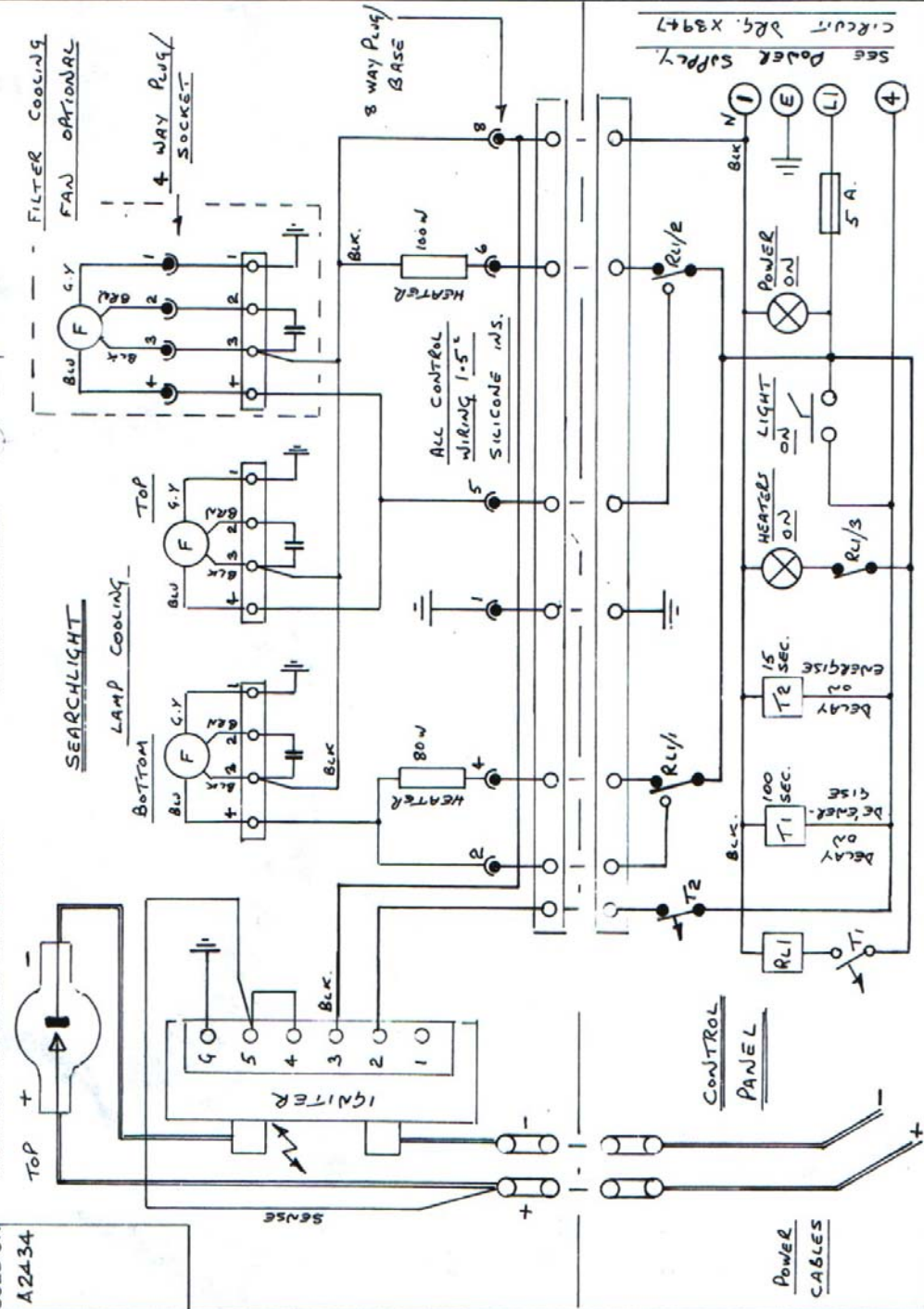

STANDARD PRACTICE:—
De-Burr: Completely all Cut or Machined Edges
Break all Corners RO.25 (MAX) unless stated.

UNLESS OTHERWISE STATED:—
Threads are to be ISO Metric COARSE Pitch
TOLERANCE on drilled holes $\pm 1\%$ or $\pm .05$ which ever is greater
TOLERANCE on Machined Dimensions ± 0.25
TOLERANCE on Hole Centres ± 0.125
TOLERANCE on Formed Dimensions ± 0.50
TOLERANCE on Cast Dimensions ± 0.50
IMPERIAL Dimensions in (brackets) are to be used as Secondary Alternatives.



FRANCIS SEARCHLIGHTS (1990) LIMITED . UNION ROAD . BOLTON . BL2 2HJ © A3

| DRAWN | DATE | MATERIAL | FINISH | DESCRIPTION | PART No / DRG. No | SHT |
|--------|--------|----------|--------|-----------------|-------------------|-----|
| g.d.o. | 5-6-92 | | | CONTROL CIRCUIT | 15094 / X3938 | 1 |

ALL DIMENSIONS IN MILLIMETRES

FIRST USED ON A2434

DO NOT SCALE DRAWING

THIRD ANGLE



ISOLATOR UNIT AND POWER SUPPLY UNITS TO BE INSTALLED IN A PROTECTED ENVIRONMENT.

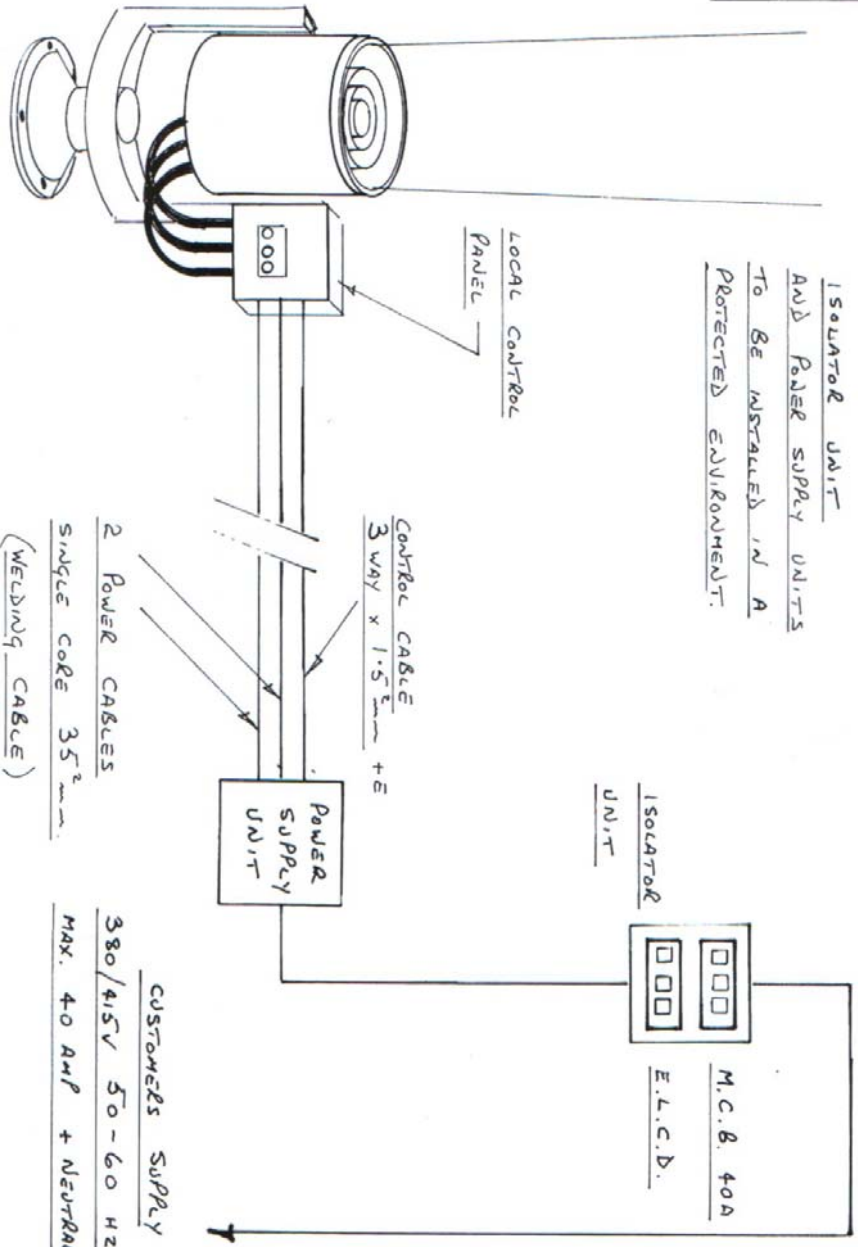

| | | |
|---------|--------|----------|
| DRAWN | DATE | MATERIAL |
| JKO | 9-6-92 | |
| CHECKED | SCALE | |
| | | |

FRANCIS SEARCHLIGHTS (1990) LIMITED, UNION ROAD, BOLTON, BL2 2HU © A3

DESCRIPTION: SCHEMATIC WIRING. ONE OF SIX SEARCHLIGHTS



| | |
|-------------------|-----|
| PART No./DRG. No. | SHT |
| X 3946 | 1 |

| ISSUE NO. | MODIFICATION DETAILS | DATE & INITIALS |
|-----------|----------------------|-----------------|
| 1 | AS FIRST DRAWN | JKO 9-6-92 |
| 2 | INDIVIDUAL SUPPLIES | JKO 22-6-92 |

STANDARD PRACTICE:—
 De-Burr Completely all Cut or Machined Edges
 Break all Corners R0.25 (MAX) unless stated

UNLESS OTHERWISE STATED:—
 Threads are to be ISO Metric COARSE Pitch
 TOLERANCE on drilled holes + 1% or ± 0.05 which ever is greater
 TOLERANCE on Machined Dimensions ± 0.25
 TOLERANCE on Hole Centres ± 0.125
 TOLERANCE on Formed Dimensions ± 0.50
 TOLERANCE on Cast Dimensions ± 0.50
 IMPERIAL Dimensions in (brackets) are to be used as Secondary Alternatives

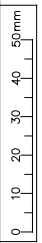
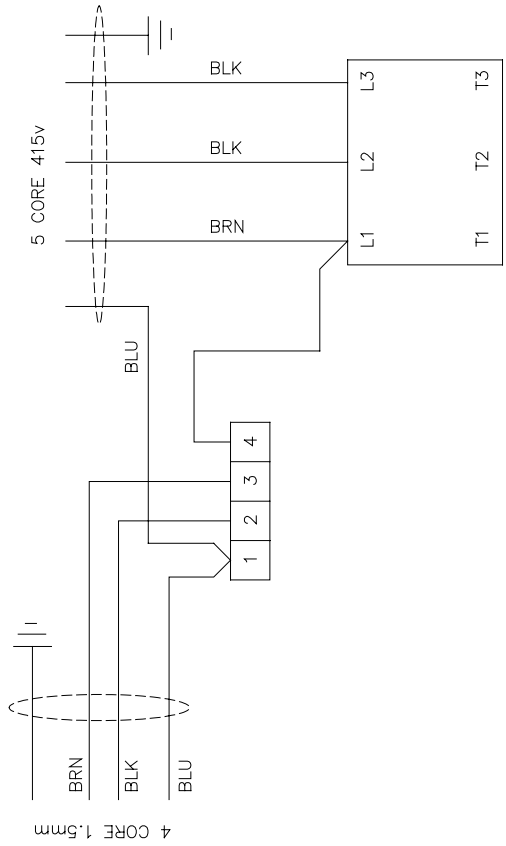

| | | | | | | | | | | | | | |
|---|--|----------------------|--|------------------|--|---|--|--------|--|----------------------|--|--------------|--|
| FIRST USED ON | | DO NOT SCALE DRAWING | | THIRD ANGLE PROJ | |  | | ISS No | | MODIFICATION DETAILS | | DATE & INT'S | |
| | | | | | | | | 1 | | AS FIRST DRAWN | | 11.04 D.S. | |
|  | | | | | | | | | | | | | |
| <p>STANDARD PRACTICE Deburr all cut/machined edges Break corners R0.25(Max) U.O.S. TOLERANCES U.O.S. :- General: ± Angular: ± Hole centres & posns: ± Sand Casting: To ISO 8062 CT10 Die Casting: To ISO 8062 CT8</p> | | | | | | | | | | | | | |
|  | | | | | | | | | | | | | |
| FRANCIS SEARCHLIGHTS LIMITED. UNION ROAD. BOLTON. BL2 2HJ | | | | | | | | | | | | | |
| © 2004 A3 CONT ON SHEET | | | | | | | | | | | | | |
| PART No./DRG No.] C23209 | | | | | | | | | | | | | |
| SHT 1 | | | | | | | | | | | | | |
| DESCRIPTION PSU WIRING | | | | | | | | | | | | | |
| FINISH | | | | | | | | | | | | | |
| MATERIAL 10.11.04 | | | | | | | | | | | | | |
| DATE 10.11.04 | | | | | | | | | | | | | |
| SCALE | | | | | | | | | | | | | |
| ALL DIMENSIONS IN MILLIMETRES | | | | | | | | | | | | | |

8 - Spare Parts List

The following spare parts can be ordered directly from the manufacturer:

| Part Number | Description |
|-------------|--------------------------------|
| C15064-00 | Exhaust Filter (Exhaust Boxes) |
| C14811-00 | Access Cover Gasket |
| C14810-00 | Fan Box Gasket |
| C21252-00 | Front Glass |
| C21253-00 | Front Glass Gasket |
| C13133-00 | Reflector |
| C14794-01 | Focus Lockwheel Assembly |
| C15063-00 | Inlet Filter (Fan Box) |
| C14771-00 | Fan |
| C14798-00 | Heater 100w |
| C14799-00 | Heater 80w |
| C14854-00 | Power Supply Unit |
| D12963 | Lamp |
| C12081-00 | Ignitor |

In order to prolong the life and performance of your product, we recommend that you only specify Francis Searchlights spare parts. This will ensure that any warranties on your equipment will not be invalidated.

When ordering spare parts please contact the Sales Department at Francis Searchlights Limited. Please quote searchlight model and serial number at all times. This will enable a fast response to your spares' requirements.