



## User Instruction & Installation Manual

### Voyager Remote Control Xenon Searchlight



#### Product Reference Number:

A6051 – VX330 WHITE 24v 150w

A6052 – VX330 MIRRORED STN.S (CHROME) 24v 150w

#### *Manufacturers details:*

Francis Searchlights Ltd  
Union Road, Bolton  
**Lancashire, BL2 2HJ, UK**  
Tel: +44 (0) 1204 558960  
Fax: +44 (0) 1204 558979  
<http://www.francis.co.uk>  
E-mail: [sales@francis.co.uk](mailto:sales@francis.co.uk)

#### *Distributor details:*

Manual Part Number: C24350

Issue : 2

## CONTENTS

- 1 - Introduction
- 2 - Safety Precautions
- 3 - Technical Information
- 4 - Unpacking and Installation Instructions
- 5 - Electrical Installation
- 6 - Operating Instructions
- 7 - Fault Finding
- 8 - Maintenance and Servicing
- 9 - Wiring Diagrams & General Assembly
- 10 - Spare Parts List

## 1 - Introduction

**It is imperative that this manual is read carefully and understood before installing your equipment. For your future reference please keep this manual in a safe place.**

Thank you for specifying a product from the Francis Searchlights range. All Francis products are designed to give complete customer satisfaction and are manufactured to the highest engineering standards in order to ensure optimum performance and service life.

The Francis range combines features proven over many years service in the most hazardous conditions in both marine and land installations.

In order to prolong the life and performance of your product, we recommend that you only specify Francis Searchlights spare parts. This will also ensure that any warranties on your equipment will not be invalidated. Information on spares ordering and parts is provided in this manual.

Should you ever need to contact Francis Searchlights Ltd. regarding your equipment, please quote the Product Serial Number at all times.

## 2 - Safety Precautions

The following instructions must be adhered to, in order to ensure a safe working environment and the safety of the user.

**Note: When unpacking or manoeuvring the searchlight into its fixing position, suitable lifting points must be used in order to prevent damage to the equipment or personal injury.**

- Prevent rain, snow, condensation and water droplets from contacting the lamp as this may cause bulb failure and possible shattering;
- Quartz halogen bulbs run with a high internal pressure in excess of atmospheric. Whilst the construction is inherently strong, there is a slight risk of the bulb shattering;
- Never look directly into an illuminated searchlight as this may cause severe damage to eyesight. If it is necessary to inspect a lamp whilst in operation, always wear suitable protective goggles;
- Should it be necessary to examine the lamp with the front bezel removed, always use a protective shield and wear goggles to ensure a safe working environment;
- Never attempt to clean a lamp whilst in use;
- Searchlights get hot. Never touch the unit when lit and always allow 15 to 20 minutes for cooling down after turning the searchlight off;
- Never place anything on or cover the searchlight when in use;
- Ensure the lamp has cooled sufficiently before removal;
- If undue force appears necessary to remove the lamp, the equipment should be inspected by a competent person or contact the manufacturer;
- When breaking a lamp for disposal, care must be taken to ensure the glass fragments are safely contained. This operation must be performed out of doors in free air. In all circumstances refer to the lamp manufacturers instructions packed with the lamp;
- Due to the vast range of lamps available it may appear possible that more powerful lamps can be used in the equipment than for which it was designed. Even when the unit will physically accept a higher wattage or voltage lamp, this substitution is not recommended and is dangerous. This action will also void any warranties on the equipment.

**Always refer to the lamp manufacturers technical data when dealing with lamps.**

### 3 - Technical Information

This product has been designed to operate in accordance with the product specification. The VX330 RC searchlight has the following features:

- All marine grade materials and fixings;
- Parabolic glass reflector;
- Stove enamel painted or Mirrored 316 Stainless Steel (Chrome);
- 350° horizontal rotation;
- Vertical movement +20° to -20°;
- Motor speed 2°- 20°/sec (Pan). 10°/sec (Tilt);
- Remote focus facility;
- Self Regulating internal heater;
- Toughened front glass;
- Sealing to IP66;

The searchlight also performs to the following optical data:

- Xenon light source
- Lamp Wattage - 150 Watts;
- Supply voltage – 24v DC;
- Peak Beam Candlepower – 5,479,861 lux;
- Range – 2,341 metres;
- Adjustable lamp focus, 1.5° spot to 10° flood;
- Temperature range: -50°C

In order that the searchlight operates correctly it is imperative that competent personnel are responsible for the installation, operation and servicing of this equipment. Failure to adhere to this advice may cause premature failure or incorrect operation of the searchlight, which may damage the equipment or cause personal injury.

## 4 - Unpacking and Installation Instructions

The following instructions should be read and fully understood prior to installing the equipment to ensure that the correct procedures are followed and all safety precautions are observed.

**Note: If the equipment has been in storage for a considerable amount of time, it is advisable to conduct a routine maintenance check on all parts before installation.**

### Safety Precautions

This equipment should not be connected to an electrical supply before being installed. Installation procedures should be adhered to in order to ensure a safe working environment and reduce the risk of damage or personal injury.

### Preparing the Mounting Position

Mark out and drill the fixing holes through the deck. If anti-vibration mounts are to be fitted, the fixing holes for the mounts should also be marked out and drilled. Prior to manoeuvring the searchlight into its' fixing position, the AV mounts should be fitted to the base. When in the desired position, bolt the searchlight firmly down. On an uneven surface it may be necessary to use a suitable sealant such as silicone, in order to ensure a weatherproofed joint. See drawing A2645 for details

## 5 - Electrical Installation

For safety purposes, only competent personnel should perform the electrical installation. All equipment should be installed to current Electrical Regulations and Standards.

In order to obtain the maximum light output from the searchlight, it is essential that the full operating voltage of the lamp fitted be applied to the lampholder contacts.

### Method of Electrical Connection

- 1) Disconnect the supply before working on the electrical system;
- 2) The searchlight must be connected to a fused electrical supply, using suitably sized cable;
- 3) If the searchlight is located a considerable distance from the supply, provision must be made in the cable size in order to overcome the voltage drop. The following table should be used for indication purposes only:

The following table below indicates the maximum length of cable to be used for the supply cable, from the control panel to the searchlight:

Searchlight	12v 150w	24v 150w
Cable Size (mm <sup>2</sup> )	Distance Max	Distance Max
6.0	5 MTRS	20 MTRS
10.0	8 MTRS	34 MTRS

- 4) Whenever possible cable terminations should be made below deck and with approved terminal devices;
- 5) If a spare auxiliary fuse or circuit breaker is not available, one of the correct type and rating should be fitted and connected to a positive supply. It is advisable to locate a bus bar or main connection and avoid any direct connection to the supply:

**Note: This equipment must be earthed.**

## Installation Guidelines

**A typical installation and connection routine for the VX330 RC 24v searchlight is as follows:**

Referring to wiring diagram C24349, a 24v supply is fed to the junction box, which then provides a common feed to the control panel and searchlight.

The searchlight has been pre-wired with 3 meters of cable from the searchlight to junction box provided.

The Mains cable to the Control Panel to be supplied by the customer.

The searchlight is pre-wired along with the connecting cable to the PSU.

Cables requiring connection by customer:-

Connect the 12 core 0.5mm<sup>2</sup> (3 metres supplied) from Searchlight to the joystick control panel.

It may be necessary for the customer to provide a suitable junction box if the cable lengths required exceed the standard length supplied. If required please contact FSL for further assistance regarding this matter.

When the light is in operation the output from the PSU should be 20v at 15 amps.

### Basic Operation

When the searchlight is turned on a 24v supply is fed to the PSU. This in turn generates a sufficient voltage to the ignitor in order that the ignition voltage is achieved and the Xenon lamp strikes.

After the lamp has lit, the PSU regulates the voltage through the ignitor so that the lamp operates within its design parameters.

Once the searchlight has been switched off allow approximately 30 seconds for the lamp to cool down before re-striking the lamp.

### Optional Slave Panel Wiring

12 core 0.5mm<sup>2</sup> cable from the Slave Panel to the Junction Box.

**NOTE both panels MUST NOT be operated simultaneously as this may damage the equipment**

## 6 - Operating Instructions

This equipment is designed for use out of doors, in free air. Never place anything on, or cover the searchlight when in use as this may present a hazard.

The searchlight can be remotely positioned via the joystick control panel, with the facility for movement up, down, left and right.

The pan speed can be adjusted using the potentiometer mounted on the joystick panel. The movement increases from 2° to a maximum of 20°/sec when turned clockwise. The tilt speed runs at 10°/sec and cannot be adjusted.

The beam of the searchlight can be adjusted to give a variety of beam types. Using the yellow remote focus button on the joystick panel, the desired beam can be achieved for any particular application. The beam will move continuously through 'spot' to 'flood'. In order to fix the beam type; simply release the button at the desired position.

The heaters specified on this equipment are self-regulating and will shut off when they reach the dew point temperature.

### Key Fob Operation

The searchlight has the additional feature of a wireless key fob, which allows the user to operate the light from a maximum distance of up to 30 metres. The key fob has an 8-way direction control and the facility to switch the light on/off. To activate the key fob simply hold down the on/off switch for a few seconds, while powering up junction box. The searchlight can have a maximum of four key fobs all working independently from each other. The above procedure must be repeated when adding additional key fobs. When not in use the key fob will go into a sleep mode.

There is the option for added slave panels, the slave panel has all the features of the main panel ie joystick, speed control focus and on/off.

**NOTE both panels MUST NOT be operated simultaneously as this may damage the equipment.**

**This product should not be used for any purpose other than for which it was designed. Any modifications to the product should not be undertaken without consulting the manufacturer.**

## Setting to Work

Safe service in use necessitates the strict observance of the following precautions.

- Any article fabricated from quartz or glass is inherently fragile and care should therefore be taken, at all times, when handling lamps;
- Eye protection must be worn when handling lamps that have been removed from their packaging materials. The protective sleeve should not be removed from the lamp for safety reasons, as there is a remote possibility of the lamp shattering violently, especially if it is subjected to mechanical shock or vibration;
- Ensure that the power rating of the lamp to be fitted is suitable for the lamp house and power supply equipment;
- Always isolate the equipment from the supply before inserting a lamp;
- Before inserting the lamp ensure that all contacts are clean. Contacts must be renewed at the slightest sign of corrosion. Sanding or filing down corroded areas is not recommended as this will only make the conducting surface between the pin and lamp holder smaller, thus causing the lamp to overheat;
- Do not twist or bend the fused quartz bulb when fitting the lamp as mechanical stresses MUST be avoided;
- When inserting or removing a lamp, always hold it securely by its' base in order to prevent breakage between base and bulb;
- The lamp holder must not exercise mechanical tensions on the lamp, neither during insertion or operation. Contacts must not discolour during use;
- For safety reasons, the lamp should be replaced once it has reached its' average life, and not later than 1.25 times the stated life otherwise the risk of the lamp exploding increases due to alterations within the quartz;
- Before the protective sleeve is removed, suitable protection must be worn i.e. face mask and gloves with wrist protection;
- Never touch the quartz bulb with bare hands, as fingerprints will make the glass cloudy and cause a severe loss of light. This may also cause recrystallisation and thus weaken the bulb material. Should the bulb be inadvertently touched, remove fingerprints with methylated spirit and a clean, soft paper towel. The bulb should then be wiped with distilled water. NOTE: ALWAYS WEAR MASK AND GLOVES DURING CLEANING);
- All packaging and the protective sleeve must be retained for re-use. Whenever removing a lamp, the protective sleeve must always be used for safety reasons;

**In all circumstances the lamp manufacturers data should be referred to when dealing with lamps.**

## 7- Fault Finding

All fault finding must be conducted by a competent person or qualified Electrical Engineer.

Please refer to the following table for trouble-shooting.

Fault	Cause	Remedy
<ul style="list-style-type: none"> <li>■ Wrong Polarity</li> </ul>	<ul style="list-style-type: none"> <li>■ Lamp incorrectly fitted</li> <li>■ Faulty wiring</li> </ul>	<ul style="list-style-type: none"> <li>■ Anode (large electrode) must always be on top in vertical burning position</li> <li>■ Check polarity, transpose connections if necessary</li> </ul>
<ul style="list-style-type: none"> <li>■ Cap overheated</li> <li>■ Cap temperature above 230°C</li> </ul>	<ul style="list-style-type: none"> <li>■ Faulty contacts</li> <li>■ Cooling equipment defective</li> </ul>	<ul style="list-style-type: none"> <li>■ Check terminals, tighten or renew</li> <li>■ Check cooling equipment and replace if necessary</li> </ul>
<ul style="list-style-type: none"> <li>■ Arc unsteady</li> </ul>	<ul style="list-style-type: none"> <li>■ Lamp operated outside current control range</li> <li>■ Magnetic stabilisation for horizontal operation defective</li> </ul>	<ul style="list-style-type: none"> <li>■ Correct current setting</li> <li>■ Check magnetic stabilisation</li> </ul>
<ul style="list-style-type: none"> <li>■ Bulb draws in air</li> </ul>	<ul style="list-style-type: none"> <li>■ Crack in graded seal caused by overheated cap</li> <li>■ Maximum cap temperature 230°C</li> </ul>	<ul style="list-style-type: none"> <li>■ Check terminals - tighten or renew</li> </ul>
<ul style="list-style-type: none"> <li>■ Glass erosion on fused quartz bulb</li> </ul>	<ul style="list-style-type: none"> <li>■ Lamp operated outside current control range</li> <li>■ Lamp service life exceeded</li> </ul>	<ul style="list-style-type: none"> <li>■ Correct current setting</li> <li>■ Check meter</li> </ul>
<ul style="list-style-type: none"> <li>■ Electrodes damaged</li> <li>■ Premature blackening</li> </ul>	<ul style="list-style-type: none"> <li>■ Current ripple too high</li> <li>■ Auxiliary mirror incorrectly adjusted</li> </ul>	<ul style="list-style-type: none"> <li>■ Have power supply inspected</li> <li>■ Adjust auxiliary mirror</li> </ul>
<ul style="list-style-type: none"> <li>■ Asymmetrical blackening of lamp (in horizontal burning position)</li> </ul>	<ul style="list-style-type: none"> <li>■ Lamp operated too long in same position</li> </ul>	<ul style="list-style-type: none"> <li>■ Turn lamp through 180° after half service life</li> </ul>

## Failure of Lamp to ignite

In the event of the lamp failing to light the following steps should be taken:

- 1) Check that the supply is connected to the input of the PSU and check all connections as per the wiring diagram. On operation if the lamp does not light, switch off supply and check all fuses;
- 2) Check the Ignitor. On your command get an operator to switch on the light for approximately 2 seconds. During this time listen for any noise (cracking or hissing) coming from within. If this arcing is heard switch off the supply. Remove the searchlight body to expose the two supply leads from the PSU enclosure to the lamp. Using a dry cloth wipe these leads to remove any dust, moisture or condensation that may have formed around the inside of the barrel. Replace the body, ensuring the screws are securely fastened, and perform the check again, listening for the cracking. If the lamp still fails to ignite, switch off at the supply and replace the lamp in accordance with the safety procedures within the manual and the manufacturer information.

**Any further tests to be carried out with regards to lamp failure must be conducted by a competent electrical engineer and should not be carried out in an explosive atmosphere.**

Before a lamp will ignite, the electrically insulated gas between the electrodes must be ionised. This is done by the ignitor which produces a high frequency voltage (up to 25,000 volts or higher). Switching the lamp on activates the ignitor. A cracking or hissing noise should be heard. The ignitor is housed within the searchlight. If found to be faulty return to Francis Searchlights Ltd for evaluation and repair.

## Failure of Remote Focus

*Causes:*

- 1) Power not supplied;
- 2) Faulty connections;
- 3) Failed motor;

*Remedy:*

- 1) Check voltage at supply and the output from the control board in the junction box. If no supply present fault is at customer supply. If power is present see remedy 2;
- 2) Check all wiring connections on motor and terminal block in accordance with the wiring diagram. If found to be correct, see remedy 3;
- 3) Remove the focus motor and apply 24v DC directly across terminals. If motor does not rotate the unit has failed. A new focus motor should be fitted to the lampholder assembly.

[Back To Top](#)

## 8 - Maintenance and Servicing

In order to prolong the service life and performance of your searchlight, the following maintenance guidelines are recommended:

- Maintenance checks should be conducted before every voyage or at least every three months;
- Before checking, disconnect the equipment from the supply;
- Visually inspect the condition of the equipment;
- Any major or minor structural damage should be rectified immediately in order to reduce sympathetic wear;
- After inspection it may be necessary to clean the inside of the searchlight. The following procedure should be adhered to:
  - Remove the front bezel;
  - Clean the front glass inside and out using a proprietary glass cleaner or metal polish;
  - Clean the reflector if required;
  - Ensure that the lampholder is free from corrosion or other damage;
  - Check earthing point for conductivity;
- It is advisable to check all seals and gaskets for signs of degradation. Renew if necessary;
- The searchlight is fitted with two breather units. This ensures a steady airflow in order to prevent any vacuum forming within the barrel.
- Upon completing all maintenance requirements the searchlight should be tested for full working order (approximately 20 minutes).

**If in any doubt as to the correct servicing procedures to adopt please contact your distributor/agent or the manufacturer who will be able to advise the best course of action for your product.**

## 9 - Wiring Diagrams and General Assembly

Drawing Number	Description
C24349	Wiring Diagram <b>With Wireless</b>
C24375	Wiring Diagram <b>Without Wireless</b>
C23949	Slave Panel Wiring Diagram
C24497	<u>Multiple</u> Slave Panel Wiring Diagram
A2645	VX330RC 150w L.V Variable Speed General Assembly Drawing
C23991	Control Panel <b>With Wireless</b>
C24263	Control Panel <b>Without Wireless</b>
C23976	Control Panel Main Slave & Slave
C24400	Junction Box <b>With Wireless</b>
C24376	Junction Box <b>Without Wireless</b>
	Junction Box Sketch

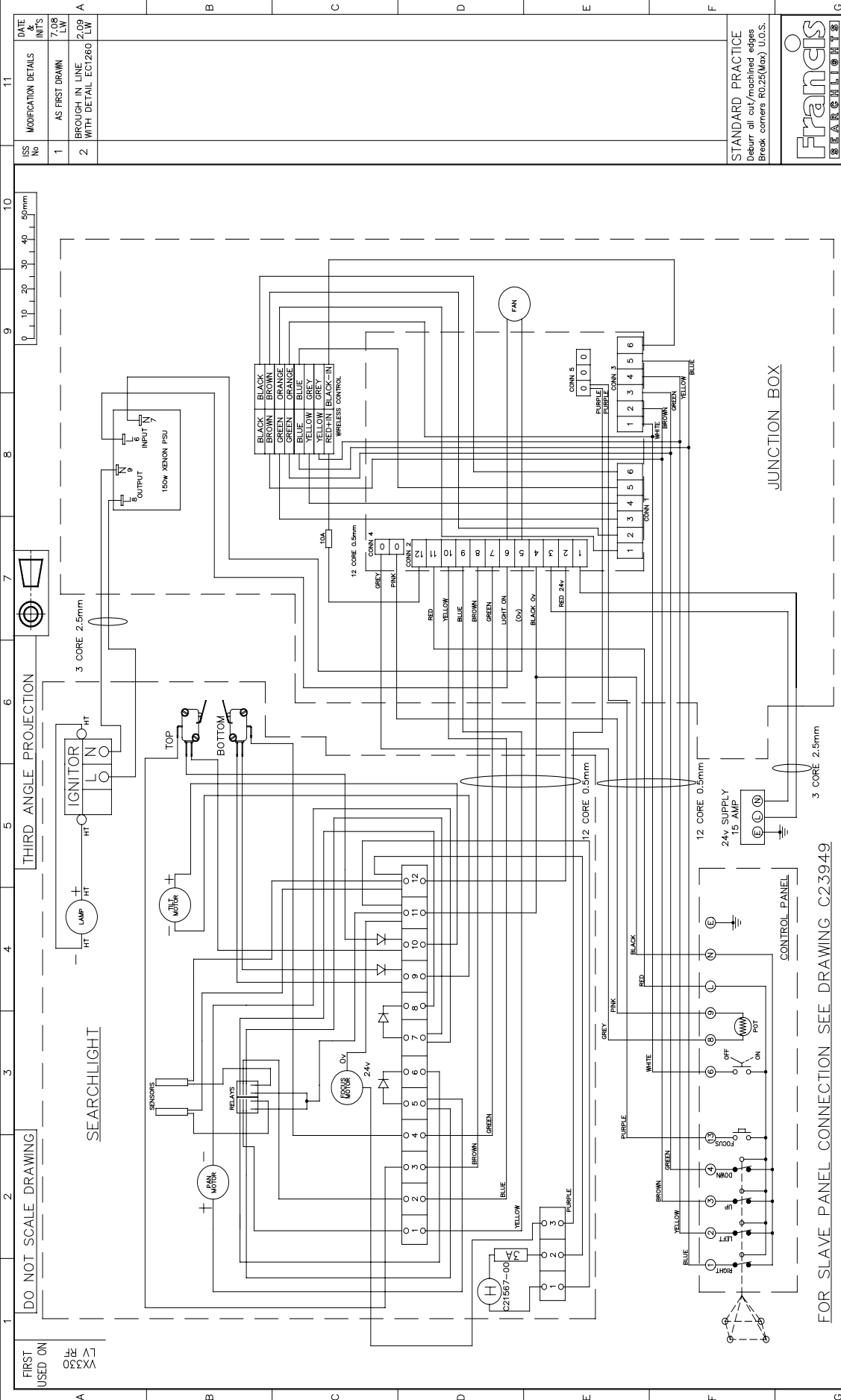

SS No	MODIFICATION DETAILS	DATE & INIT'S
1	AS FIRST DRAWN	7.08 LW
2	BROUGH IN LINE WITH DETAIL EC1260	2.09 LW

DO NOT SCALE DRAWING  
THIRD ANGLE PROJECTION  
SEARCHLIGHT

FRANCIS SEARCHLIGHTS LIMITED · UNION ROAD · BOLTON · BL2 2HU  
Sand Casting: To ISO 8062 CT10 MATERIAL  
Die Casting: To ISO 8062 CT8  
Hole centres & posns: ±

FOR SLAVE PANEL CONNECTION SEE DRAWING C23949

STANDARD PRACTICE  
Deburr all cut/machined edges  
Break corners R0.25(Max) U.O.S.

FINISH

FRANCIS SEARCHLIGHTS LIMITED · UNION ROAD · BOLTON · BL2 2HU  
Sand Casting: To ISO 8062 CT10 MATERIAL  
Die Casting: To ISO 8062 CT8  
Hole centres & posns: ±

FRANCIS SEARCHLIGHTS LIMITED · UNION ROAD · BOLTON · BL2 2HU  
Sand Casting: To ISO 8062 CT10 MATERIAL  
Die Casting: To ISO 8062 CT8  
Hole centres & posns: ±

FRANCIS SEARCHLIGHTS LIMITED · UNION ROAD · BOLTON · BL2 2HU  
Sand Casting: To ISO 8062 CT10 MATERIAL  
Die Casting: To ISO 8062 CT8  
Hole centres & posns: ±

DRAWN	LW	DATE	7.08	TOLERANCES
CHECKED	LW <td>SCALE</td> <td>1:1</td> <td>General: ± Angular: ±</td>	SCALE	1:1	General: ± Angular: ±
ALL DIMENSIONS IN MILLIMETRES				

CONTR. ON SHEET	8208	A2	CONT. ON SHEET
PART No./DRG No.	C24349		
SHT	11		

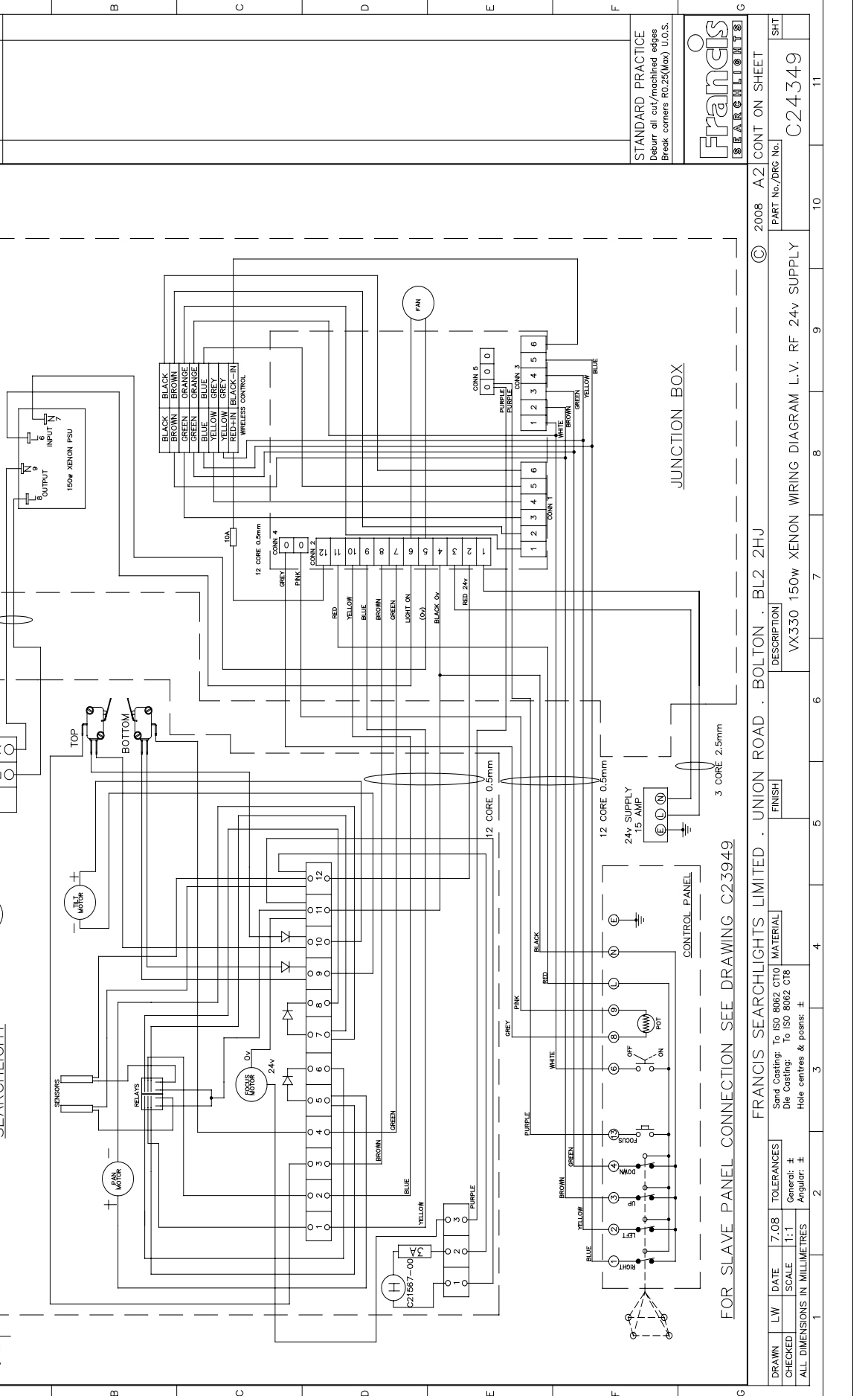

DATE	7.08	INIT'S	LW
AS FIRST DRAWN			
BROUGH IN LINE WITH DETAIL EC1260			



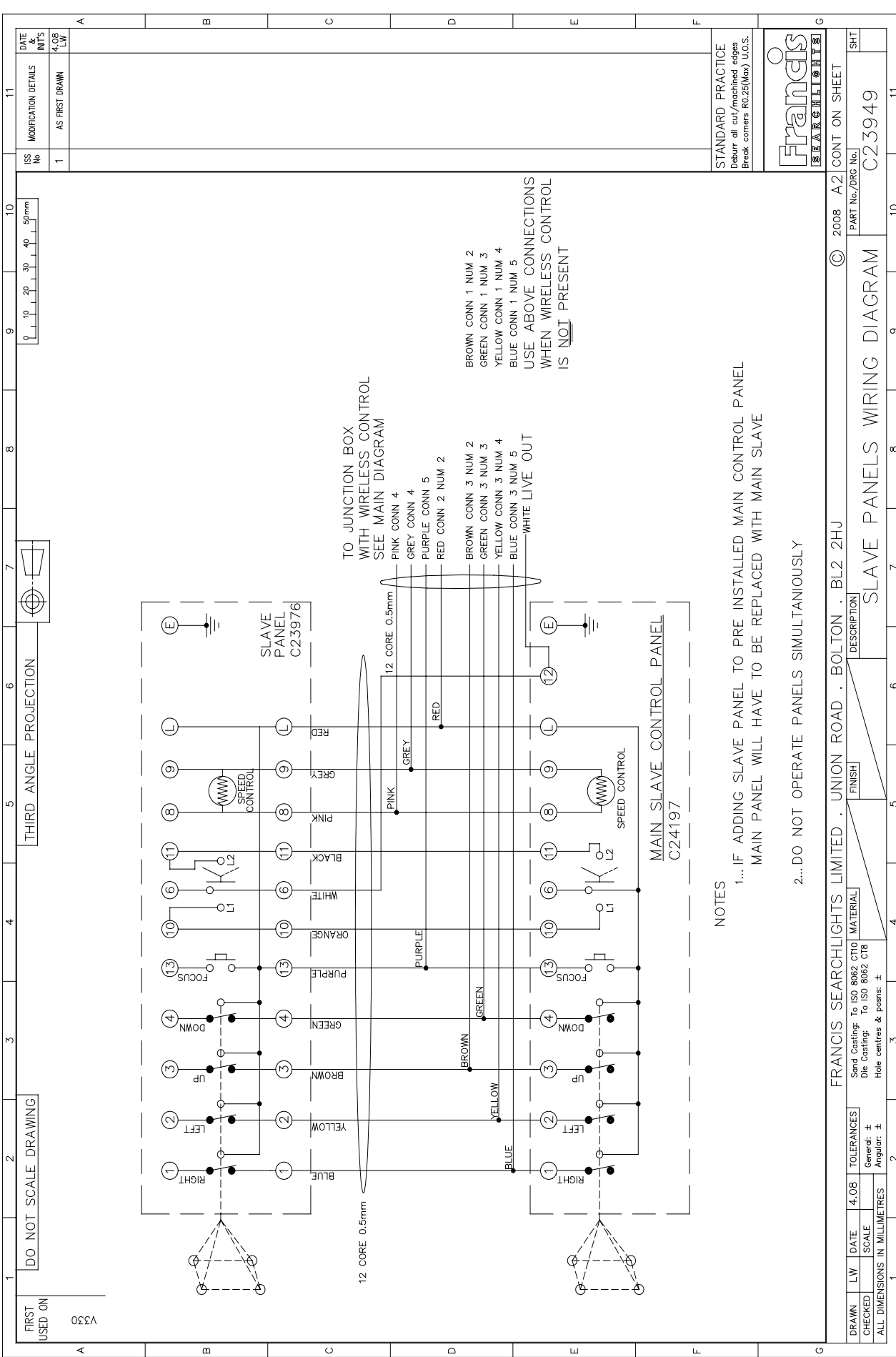

ISS No	1	AS FIRST DRAWN	DATE & INIT'S	4.08 LW
MODIFICATION DETAILS				

STANDARD PRACTICE	Debur all cut/machined edges Break corners R0.25(Max) U.O.S.			
-------------------	---	--	--	--

©	2008	A2	CONT ON SHEET
---	------	----	---------------

PART No./DRG No.	C23949
------------------	--------

DESCRIPTION	SLAVE PANELS WIRING DIAGRAM
-------------	-----------------------------

FINISH	
--------	--

MATERIAL	
----------	--

TO ISO 8062 CT10	
------------------	--

TO ISO 8062 C18	
-----------------	--

Hole centres & posns:	±
-----------------------	---

ALL DIMENSIONS IN MILLIMETRES	
-------------------------------	--

TOLERANCES	4.08
------------	------

General:	±
----------	---

Angular:	±
----------	---

UNION ROAD	BOLTON	BL2 2HU
------------	--------	---------

FRANCIS SEARCHLIGHTS LIMITED	
------------------------------	--

THIRD ANGLE PROJECTION	
------------------------	--

DO NOT SCALE DRAWING	
----------------------	--

FIRST USED ON	V330
---------------	------

SCALE	
-------	--

DATE	
------	--

LW	
----	--

FRANCIS SEARCHLIGHTS	
----------------------	--

SEARLIGHTS	
------------	--

STANDARD PRACTICE	
-------------------	--

DEBUR ALL CUT/MACHINED EDGES	
------------------------------	--

BREAK CORNERS R0.25(MAX) U.O.S.	
---------------------------------	--

© 2008	
--------	--

CONT ON SHEET	
---------------	--

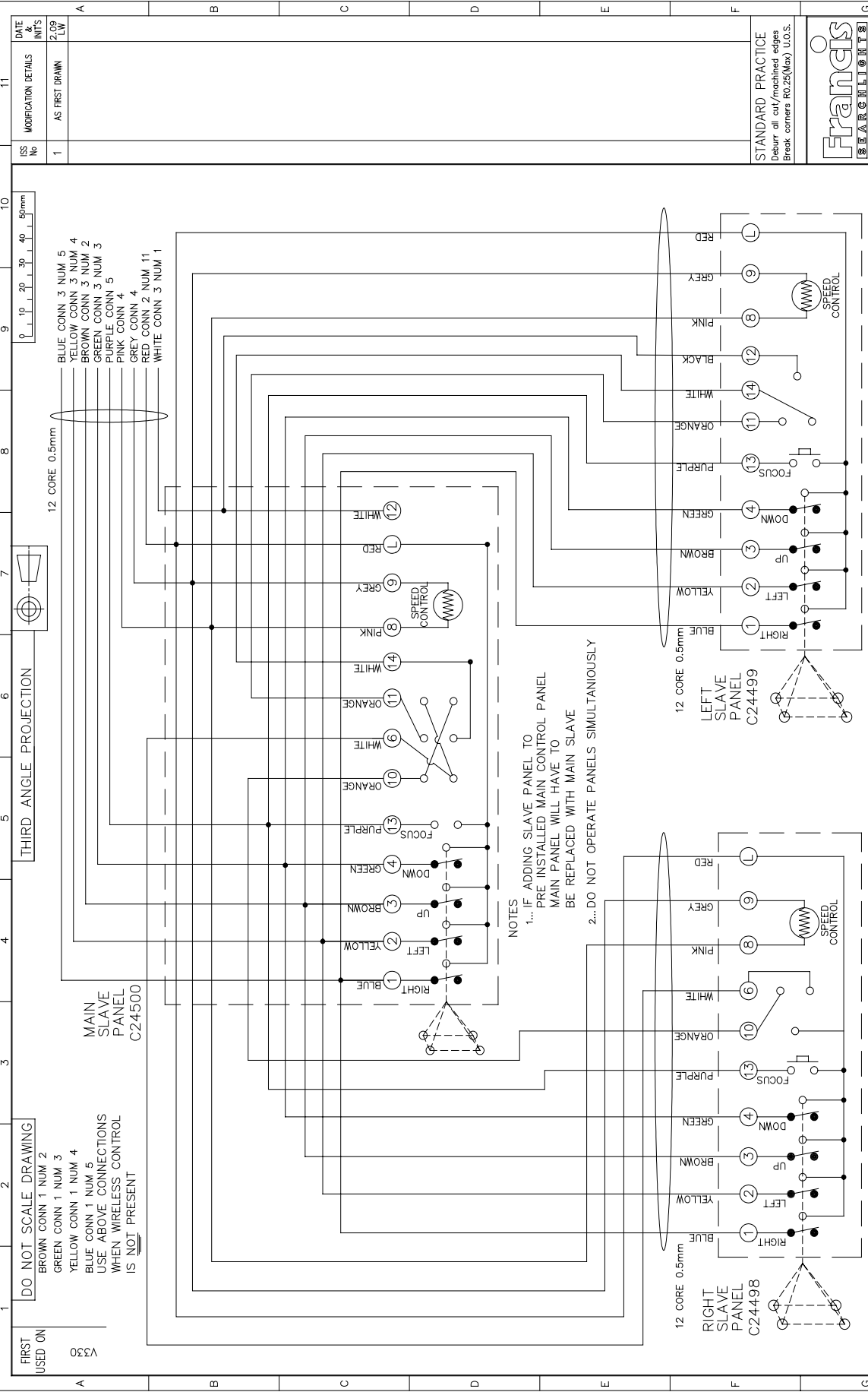

**Francis**  
SEARCHLIGHTS

FRANCIS SEARCHLIGHTS LIMITED · UNION ROAD · BOLTON · BL2 2HU	© 2009 A2	CONT ON SHEET
DESCRIPTION	PART No./DRG No.	SHT
MULTIPLE SLAVE PANELS WIRING DIAGRAM	C24497	11
FINISH		
MATERIAL		
Sand Casting: To ISO 8062 CT10		
Die Casting: To ISO 8062 C18		
Hole centres & posns: ±		
TOLERANCES	DATE	SCALE
General: ±	2.09	
Angular: ±		
DRAWN	LW	
CHECKED		
ALL DIMENSIONS IN MILLIMETRES		

DATE & INTS	2.09	LW
MODIFICATION DETAILS	AS FIRST DRAWN	
ISS No	1	

DATE & INIT'S	11
MODIFICATION DETAILS	
4.07 LW	
AS FIRST DRAWN	
1	
US No	

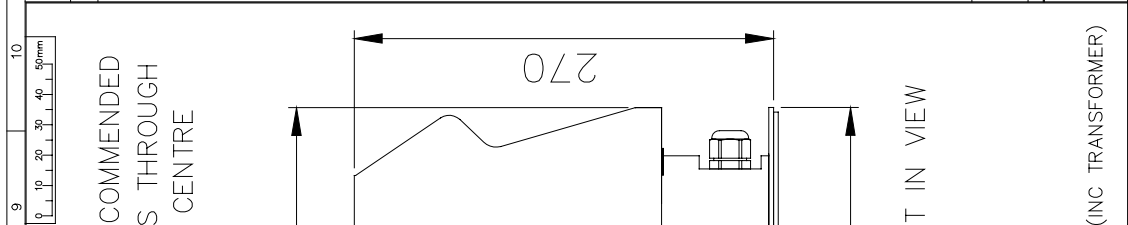

DO NOT SCALE DRAWING

THIRD ANGLE PROJECTION

FRANCIS

LIGHT IS PRE-WIRED USING CABLE GLANDS TO THE REAR BUT IF PREFERRED CAN BE WIRED THROUGH HOLE IN THE BASE PLATE. BLANKING PLUGS ARE SUPPLIED IF CUSTOMER WISHES TO CHANGE FROM WIRING AT THE REAR.

Ø22mm HOLE IS RECOMMENDED FOR CABLE TO PASS THROUGH IF WIRING THROUGH CENTRE

BASE FIXINGS  
4 HOLES Ø8.2 EQUI-SPACED  
ON A 220 P.C.D.

NOTE  
ITEMS 4, 5, 7 & 9 ARE NOT IN VIEW

- A2648 LV 250w TUNG HAL CHROME
- A2649 HV 300w XENON CHROME
- A2650 HV 150w XENON CHROME
- A6052 LV 150w XENON CHROME
- A2663 HV 575w EM ARC CHROME
- A2671 LV 250w TUNG HAL CHROME (INC TRANSFORMER)
- A2645 LV 250w TUNG HAL
- A2646 HV 300w XENON
- A2647 HV 150w XENON
- A6051 LV 150w XENON
- A2661 HV 350w EM ARC
- A2669 LV 250w TUNG HAL (INC TRANSFORMER)

ITEM PART No.	DRG No.	DESCRIPTION	QTY
1	C23946	HOUSING ASSY	1
2	C23951	BASE ASSY 250w HALOGEN	1
2	C23982	BASE ASSY 300w XENON	1
2	C23985	BASE ASSY 150w XENON	1
2	C24087	BASE ASSY 350w EM ARC	1
3	C23809	BEZEL COVER PLATE	1
4	C23803	GLASS	1
5	C09835	X2675 GASKET	1
6	C24079	GASKET	1
7	C16432	SCREW M4 x 12 SKT HD	12
8	C23954	SCREW M6 x 8 SKT BT HD	10
9	C21853	WASHER DUBO (REF 199)	12

STANDARD PRACTICE  
Debur all cut/machined edges  
Break corners R0.25(Max) U.O.S.

FRANCIS

© 2007 A2 CONT ON SHEET

PART No./DRG No. A2645

SHIT

DRAWN	LW	DATE	4.07	TOLERANCES	
CHECKED		SCALE	1:2	General: ±	
ALL DIMENSIONS IN MILLIMETRES				Hole centres & points: ±	
				Angular: ±	
FRANCIS SEARCHLIGHTS LIMITED · UNION ROAD · BOLTON · BL2 2HU				DESCRIPTION	
				VOYAGER 330 HV & LV GA	

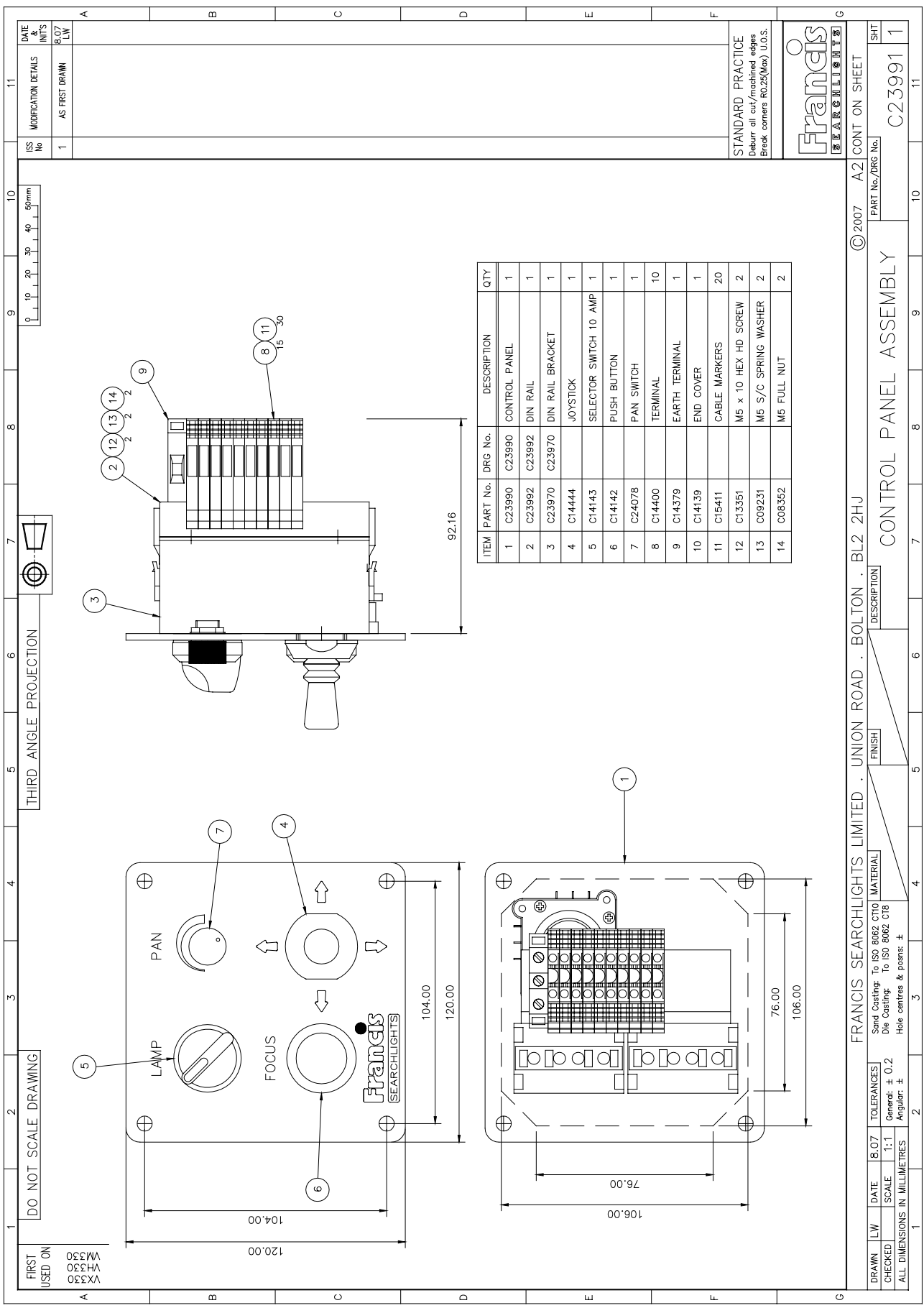

THIRD ANGLE PROJECTION

DO NOT SCALE DRAWING

FIRST USED ON  
 VM330  
 VHX30  
 VHX30

ITEM	PART No.	DRG No.	DESCRIPTION	QTY
1	C23990	C23990	CONTROL PANEL	1
2	C23992	C23992	DIN RAIL	1
3	C23970	C23970	DIN RAIL BRACKET	1
4	C14444		JOYSTICK	1
5	C14143		SELECTOR SWITCH 10 AMP	1
6	C14142		PUSH BUTTON	1
7	C24078		PAN SWITCH	1
8	C14400		TERMINAL	10
9	C14379		EARTH TERMINAL	1
10	C14139		END COVER	1
11	C15411		CABLE MARKERS	20
12	C13351		M5 x 10 HEX HD SCREW	2
13	C09231		M5 S/C SPRING WASHER	2
14	C05352		M5 FULL NUT	2

STANDARD PRACTICE  
 Debur all cut/machined edges  
 Break corners R0.25(Max) U.O.S.



© 2007 A2 CONT ON SHEET  
 FRANCIS SEARCHLIGHTS LIMITED · UNION ROAD · BOLTON · BL2 2HU

DRAWN	L/W	DATE	SCALE	1:1	TOLEANCES	General: ± 0.2	Angular: ±	FINISH	MATERIAL	DESCRIPTION	PART No./DRG No.	SHT
CHECKED										CONTROL PANEL ASSEMBLY	C23991	1



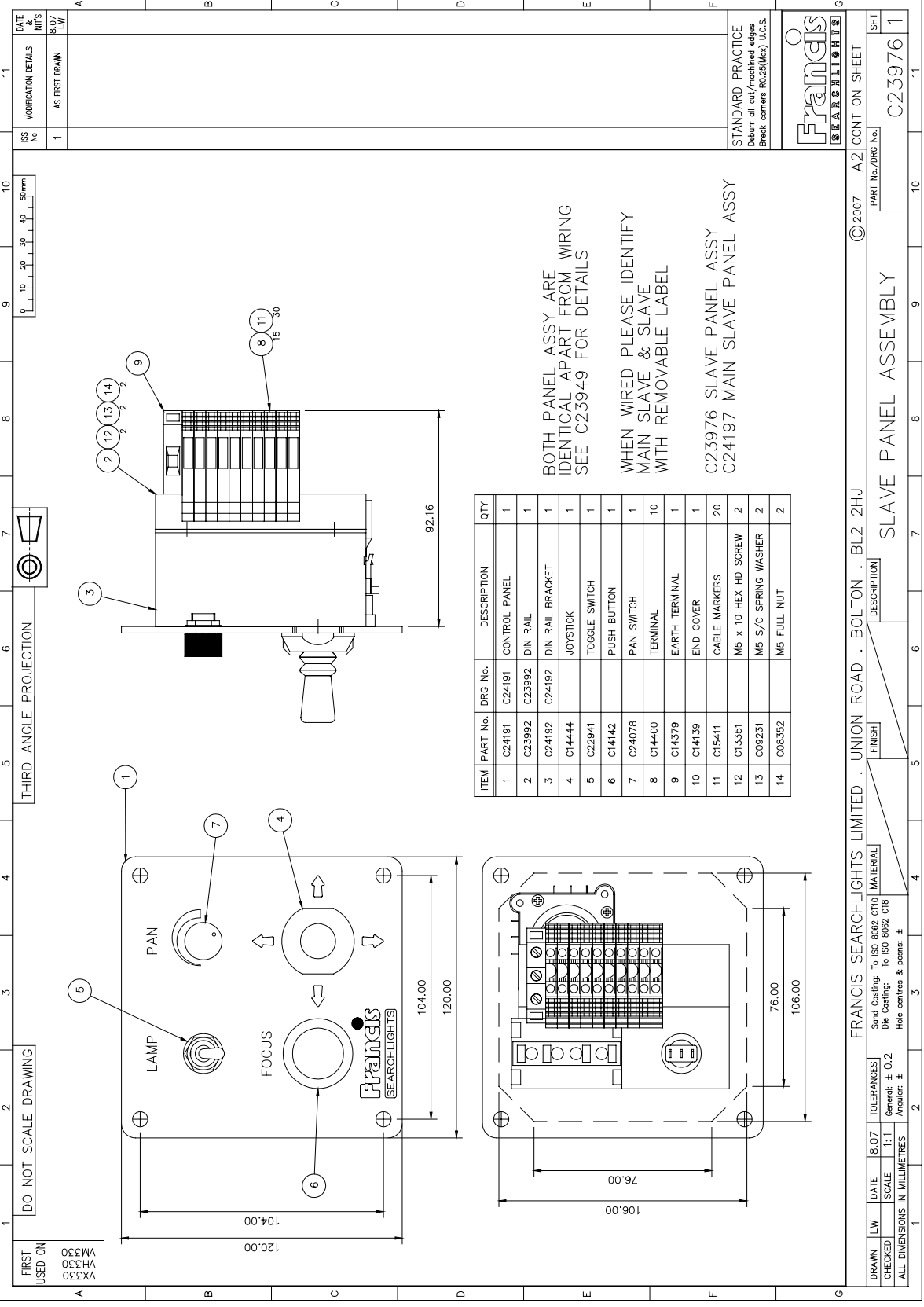

ITEM	PART No.	DRG No.	DESCRIPTION	QTY
1	C24191		CONTROL PANEL	1
2	C23992		DIN RAIL	1
3	C24192		DIN RAIL BRACKET	1
4	C14444		JOYSTICK	1
5	C22941		TOGGLE SWITCH	1
6	C14142		PUSH BUTTON	1
7	C24078		PAN SWITCH	1
8	C14400		TERMINAL	10
9	C14379		EARTH TERMINAL	1
10	C14139		END COVER	1
11	C15411		CABLE MARKERS	20
12	C13351		M5 x 10 HEX HD SCREW	2
13	C09231		M5 S/C SPRING WASHER	2
14	C08352		M5 FULL NUT	2

BOTH PANEL ASSY ARE IDENTICAL APART FROM WIRING SEE C23949 FOR DETAILS

WHEN WIRED PLEASE IDENTIFY MAIN SLAVE & SLAVE WITH REMOVABLE LABEL

C23976 SLAVE PANEL ASSY  
C24197 MAIN SLAVE PANEL ASSY

DATE & INIT'S	8.07	DATE	
MODIFICATION DETAILS		INIT'S	
ISS No	1	AS FIRST DRAWN	

STANDARD PRACTICE	
Debur all cut/machined edges	
Break corners R0.25(Max) U.O.S.	



FRANCIS SEARCHLIGHTS LIMITED . UNION ROAD . BOLTON . BL2 2HU	© 2007	A2	CONT ON SHEET
FINISH		PART No./DRG No.	C23976 1
MATERIAL	Sheet Casting: To ISO 8062 C10		
	Die Casting: To ISO 8062 C18		
	Hole centres & posns: ±		
	Angular: ±		
DESCRIPTION	SLAVE PANEL ASSEMBLY		
SHEET	11		

FIRST USED ON

OC333

WM333

OX333

OS333

HA

ALL DIMENSIONS IN MILLIMETRES



ITEM	PART No.	DRG No.	DESCRIPTION	QTY
1	C24385	C24385	ENCLOSURE DRILLING	1
2	C24373	C24373	CHASSIS PLATE ASSY	1
3	C24000		SPEED CONTROL	1
4	C16586		PSU 150w 24v XENON	1
5	C16133		TERMINAL BLOCK	1
6	C10158		M20 GLAND	2
7	C16450		M25 GLAND	2
8	C22104		FAN	1
9	C24386		FAN COVER	2
10	C20241		CABLE 12 CORE 0.5mm	3M
11	C05287		3 CORE 6.0mm CABLE	3M
12	C13872		1.5mm S/C CABLE RED	A/R
13	C13873		1.5mm S/C CABLE BLACK	A/R
14	C16112		1.5mm S/C CABLE GR/YEL	A/R
15	C14502		SCREW M3 x 6 PN HD	4
16	C10151		SCREW M3 x 10 PN HD	4
17	C10203		SCREW M3 x 16 PN HD	1
18	C14710		SCREW M4 x 12 HEX HD	2
19	C06981		SCREW M4 x 16 CSK HD	4
20	C16832		SCREW M4 x 30 CSK HD	4
21	C08028		WASHER M3 PLAIN	8
22	C04376		WASHER M4 PLAIN	8
23	C10747		WASHER M3 S/C SPRING	8
24	C08793		WASHER M4 S/C SPRING	8
25	C08286		M4 FULL NUT	10
26	C16233		YELLOW SLEEVE	4
27	C14232		HEAT SINK COMPOUND	A/R
28	C24389		LABEL (THIS WAY UP)	1

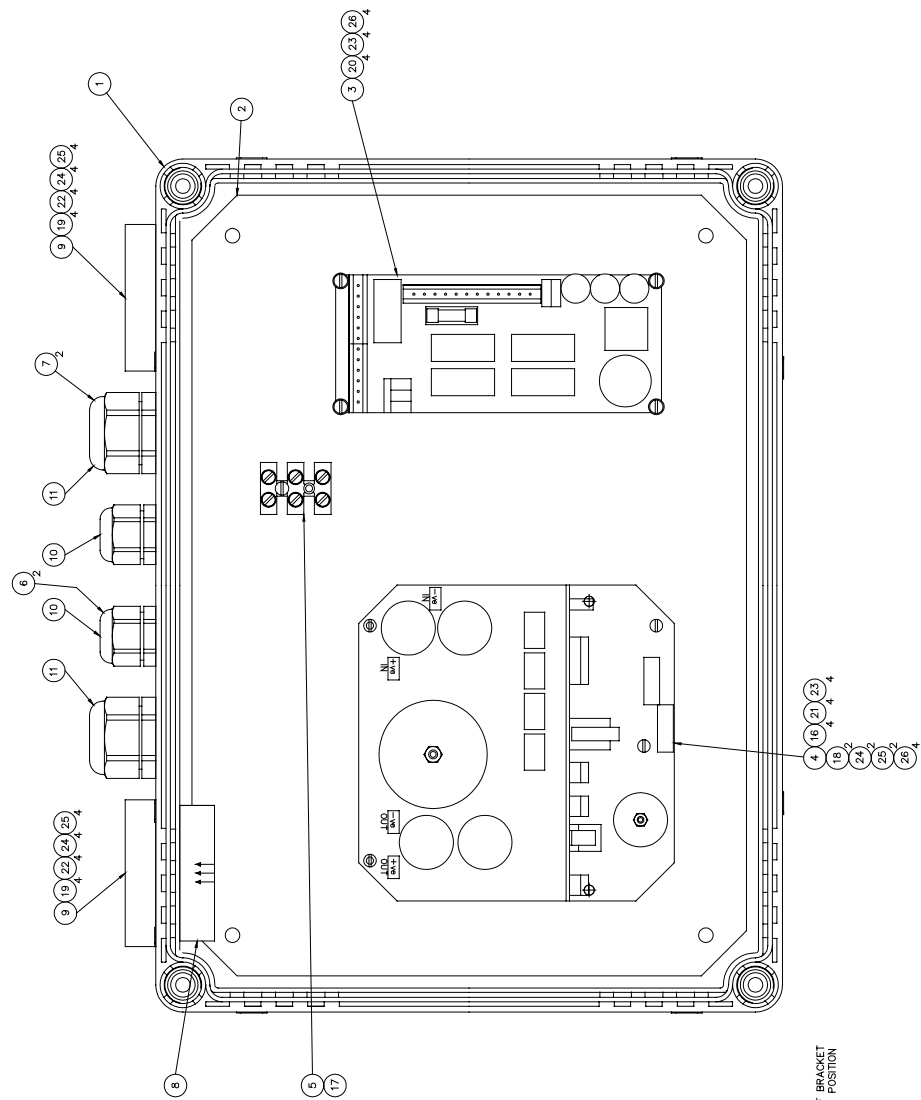
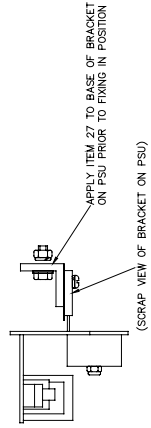

STANDARD PRACTICE  
 Drawn to conform with the British Standard BS 5400:1990  
 Block code: ROS2(M)A:10.0.5.



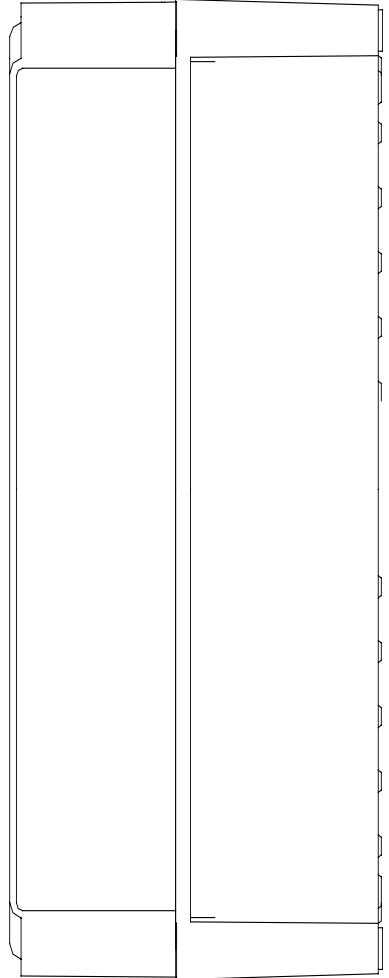
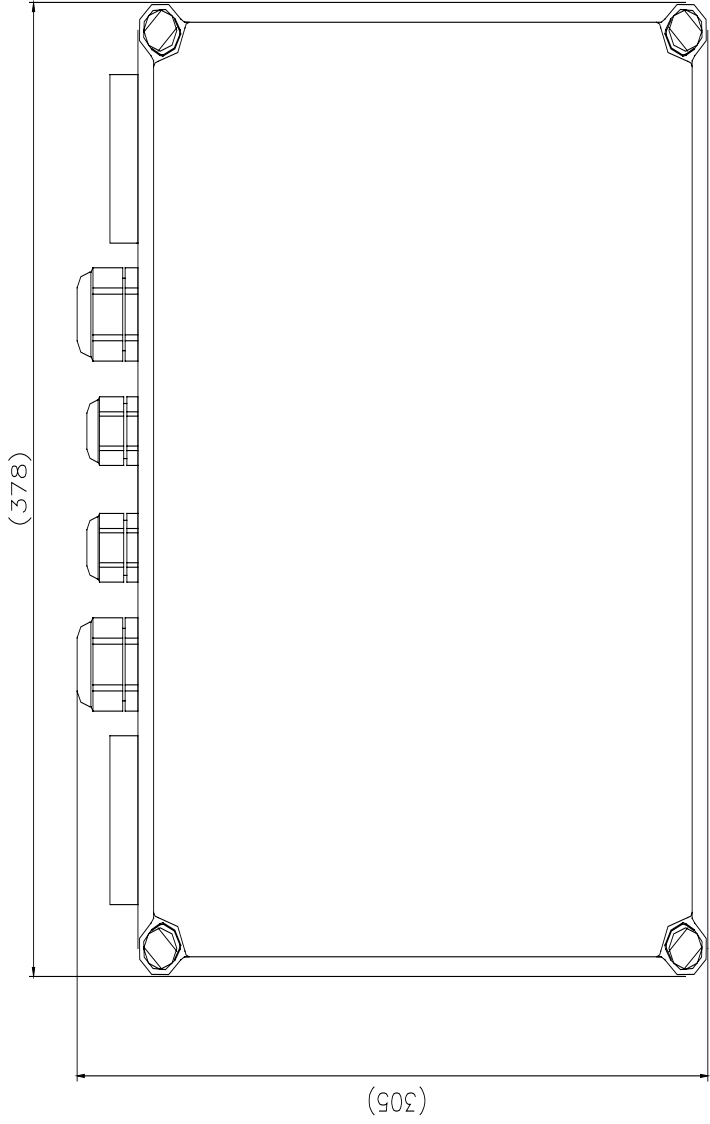
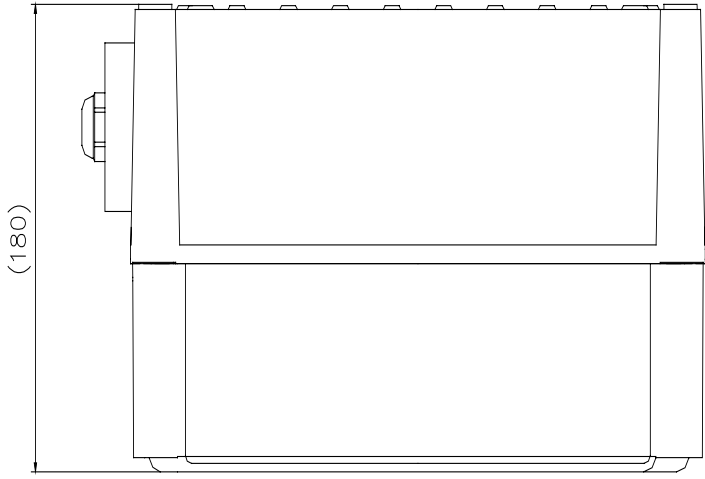

## 10 - Spare Parts List

The following spare parts can be ordered directly from the manufacturer:

Part Number	Description
D8151	150w Xenon Lamp
C14143-00	Switch 10A - On/Off
C14142-00	Switch – Focus
C14444-00	Joystick
C24078-00	Switch (Controller/Speed)
C23803-00	Front Glass
C08835-00	Front Glass Gasket
C16410-00	24v Motor – Focus and Tilt
C23802-00	Reflector
C22268-01	Breather Assy
C24089-01	Pan Motor Assy
C22382-00	Microswitch with lever
C24000-00	Speed Controller
C23805-00	Relay (Housing)
C23969-01	Sensor Block Assembly
C16596-00	150w Xenon PSU
C16592-00	PSU / Ignitor
C23960-00	Wireless Control Unit
C21567-00	Housing Heater
C21567-00	PSU heater
C23961-01	Wireless Key Pad
C24079-00	Mounting Base Gasket

In order to prolong the life and performance of your product, we recommend that you only specify Francis Searchlights spare parts. This will ensure that any warranties on your equipment will not be invalidated.

When ordering spare parts please contact the Sales Department at Francis Searchlights Limited. Please quote searchlight model and serial number at all times. This will enable a fast response to your spares' requirements.



[Back To Top](#)