



User Instruction & Installation Manual

L560 Remote Control 2/3Kw Tungsten Halogen Searchlight



Product Reference Number:

A2651 – Variable Speed Motor Unit 2/3Kw 115/240v

Manufacturers details:

Francis Searchlights Ltd
Union Road, Bolton
Lancashire, BL2 2HJ, UK
Tel: +44 (0) 1204 558960
Fax: +44 (0) 1204 558979
<http://www.francis.co.uk>
E-mail: sales@francis.co.uk

Distributor details:



Manual Part Number: C21514

Issue : 10

CONTENTS

- 1 - Introduction
- 2 - Safety Precautions
- 3 - Technical Information
- 4 - Unpacking and Installation Instructions
- 5 - Electrical Installation
- 6 - Operating Instructions
- 7 - Fault Finding
- 8 - Maintenance and Servicing
- 9 - Wiring Diagram & General Assembly
- 10 - Spare Parts List

1 - Introduction

It is imperative that this manual is read carefully and understood before installing your equipment. For your future reference please keep this manual in a safe place.

Thank you for specifying a product from the Francis Searchlights range. All Francis products are designed to give complete customer satisfaction and are manufactured to the highest engineering standards in order to ensure optimum performance and service life.

The Francis Lite range combines features proven over many years service in the most hazardous conditions in both marine and land installations.

In order to prolong the life and performance of your product, we recommend that you only specify Francis Searchlights spare parts. This will also ensure that any warranties on your equipment will not be invalidated. Information on spares ordering and parts is provided in this manual.

Should you ever need to contact Francis Searchlights Ltd. regarding your equipment, please quote the Product Serial Number at all times.

2 - Safety Precautions

The following instructions must be adhered to, in order to ensure a safe working environment and the safety of the user.

Note: When unpacking or manoeuvring the searchlight into its fixing position, suitable lifting points must be used in order to prevent damage to the equipment or personal injury.

- Prevent rain, snow, condensation and water droplets from contacting the lamp as this may cause bulb failure and possible shattering;
- Quartz halogen bulbs run with a high internal pressure in excess of atmospheric. Whilst the construction is inherently strong, there is a slight risk of the bulb shattering;
- Never look directly into an illuminated searchlight as this may cause severe damage to eyesight. If it is necessary to inspect a lamp whilst in operation, always wear suitable protective goggles;
- Should it be necessary to examine the lamp with the front bezel removed, always use a protective shield and wear goggles to ensure a safe working environment;
- Never attempt to clean a lamp whilst in use;
- Searchlights get hot. Never touch the unit when lit and always allow 15 to 20 minutes for cooling down after turning the searchlight off;
- Never place anything on or cover the searchlight when in use;
- Ensure the lamp has cooled sufficiently before removal;
- If undue force appears necessary to remove the lamp, the equipment should be inspected by a competent person or contact the manufacturer;
- When breaking a lamp for disposal, care must be taken to ensure the glass fragments are safely contained. This operation must be performed out of doors in free air. In all circumstances refer to the lamp manufacturers instructions packed with the lamp;
- Due to the vast range of lamps available it may appear possible that more powerful lamps can be used in the equipment than for which it was designed. Even when the unit will physically accept a higher wattage or voltage lamp, this substitution is not recommended and is dangerous. This action will also void any warranties on the equipment.

Always refer to the lamp manufacturers technical data when dealing with lamps.

3 - Technical Information

This product has been designed to operate in accordance with the product specification. The L560RC searchlight has the following features:

- All marine grade materials and fixings;
- Parabolic formed aluminium reflector;
- Powder coated / Stove enamel paint finish;
- 385° horizontal rotation;
- Vertical movement $\pm 20^\circ$;
- Motor speed 20°/sec fast, 10°/sec slow (Pan)
0-10°/sec fast, 0-5°/sec slow (Tilt);
- Effective weather sealing to IP66;
- Toughened front glass;

The searchlight also performs to the following optical data:

	<u>2000 Watt T/H</u>	<u>3000 Watt T/H</u>
■ Supply voltage	220/240v or 110/115v	220/240v or 110/115v
■ Peak Beam Candlepower	2,7495,697 lux	3,127,043 lux
■ Range	1657 metres	1768 metres
■ Divergence	4.8°	6.4°
■ Temperature range	-20°C to +50°C	-20°C to +50°C

In order that the searchlight operates correctly it is imperative that competent personnel are responsible for the installation, operation and servicing of this equipment. Failure to adhere to this advice may cause premature failure or incorrect operation of the searchlight, which may damage the equipment or cause personal injury.

4 - Unpacking and Installation Instructions

The following instructions should be read and fully understood prior to installing the equipment to ensure that the correct procedures are followed and all safety precautions are observed.

Note: If the equipment has been in storage for a considerable amount of time, it is advisable to conduct a routine maintenance check on all parts before installation.

Safety Precautions

This equipment should not be connected to an electrical supply before being installed. Installation procedures should be adhered to in order to ensure a safe working environment and reduce the risk of damage or personal injury.

Preparing the Mounting Position

Mark out and drill the fixing holes through the deck. If anti-vibration mounts are to be fitted, the fixing holes for the mounts should also be marked out and drilled. Prior to manoeuvring the searchlight into its' fixing position, the AV mounts should be fitted to the base. When in the desired position, and bolt the searchlight firmly down. On an uneven surface it may be necessary to use a suitable sealant such as silicone, in order to ensure a weatherproofed joint.

5 - Electrical Installation

For safety purposes, only competent personnel should perform the electrical installation. All equipment should be installed to current Electrical Regulations and Standards.

In order to obtain the maximum light output from the searchlight, it is essential that the full operating voltage of the lamp fitted be applied to the lampholder contacts.

Method of Electrical Connection

- 1) Disconnect the supply before working on the electrical system;
- 2) The searchlight must be connected to a fused electrical supply, using suitably sized cable;
- 3) If the searchlight is located a considerable distance from the supply, provision must be made in the cable size in order to overcome the voltage drop.

The following table below indicates the maximum length of cable to be used for the AC supply cable, from the control panel to the searchlight:

Searchlight	120v 2Kw	230v 2Kw	240v 2Kw	115v 3Kw	230v 3Kw
Cable Size (mm ²)	Distance Max	Distance Max	Distance Max	Distance Max	Distance Max
2.5	15 MTRS	55 MTRS	60 MTRS	9 MTRS	37 MTRS
4	24 MTRS	88 MTRS	96 MTRS	14 MTRS	58 MTRS
6	37 MTRS	137 MTRS	150 MTRS	22 MTRS	91 MTRS
10	62 MTRS	230 MTRS	251 MTRS	38 MTRS	153 MTRS

- 4) Whenever possible cable terminations should be made below deck and with approved terminal devices;
- 5) If a spare auxiliary fuse or circuit breaker is not available, one of the correct type and rating should be fitted and connected to a positive supply. It is advisable to locate a bus bar or main connection and avoid any direct connection to the supply;
- 6) For 110/220v AC products, the following colour coding system should be used for the customer supply cable:

Brown - Live
Blue - Negative
Green/Yellow - Earth

Note: This equipment must be earthed.

Installation Guidelines

A typical installation and connection routine for the L560RC 2/3Kw searchlight is as follows:

Referring to wiring diagram C23015, a supply is fed to the control panel, which then provides a common feed to the motor gearbox and the searchlight.

The searchlight has been pre-wired with 3 meters of cable from the gearbox to a junction box provided.

Cables required to be connected by the customer: -

4 core 1.5mm² cable from the Junction Box to the Control Panel.

12 core 0.5mm² cable from the Junction Box to the Control Panel.

Optional Slave Panel Wiring

6 core 0.5mm² cable from the Slave Panel to the Junction Box.

The Mains cable to the Control Panel to be supplied by the customer.

The searchlight head is pre-wired along with the connecting cable to the motor gearbox.

6 - Operating Instructions

This equipment is designed for use out of doors, in free air. Never place anything on, or cover the searchlight when in use as this may present a hazard.

The searchlight can be remotely positioned via the joystick control panel, with the facility for movement up, down, left and right. The speed of movement depends on the more pressure applied to the joystick the faster the searchlight moves. When in the desired position the joystick should be released so that it returns to its' home position, dead centre.

The variable speed gearbox has a fast and slow setting. You activate this by switching the controller switch on the control panel then selecting fast or slow.

The beam of the searchlight can be externally adjusted to give a variety of 'spreads'. Using the focussing handle situated underneath the barrel head. The lampholder can be moved into the desired position, towards the front for spot or the rear for flood.

The searchlight is fitted with a Breather Assembly. This ensures a steady airflow in order to prevent any vacuum forming within the barrel.

The heaters specified on this equipment are self-regulating and will increase/decrease the heat as required.

This product should not be used for any purpose other than for which it was designed. Any modifications to the product should not be undertaken without consulting the manufacturer.

Setting to Work

Safe service in use necessitates the strict observance of the following precautions.

- Any article fabricated from quartz or glass is inherently fragile and care should therefore be taken, at all times, when handling lamps;
- Eye protection must be worn when handling lamps that have been removed from their packaging materials. The protective jacket should not be removed from the lamp for safety reasons, as there is a remote possibility of the lamp shattering violently, especially if it is subjected to mechanical shock or vibration;
- Always isolate the equipment from the supply before inserting a lamp;
- Before inserting the lamp ensure that all contacts are clean. Contacts must be renewed at the slightest sign of corrosion. Sanding or filing down corroded areas is not recommended as this will only make the conducting surface between the pin and lampholder smaller, thus causing the lamp to overheat;
- Do not twist or bend the fused quartz bulb when fitting the lamp as mechanical stresses MUST be avoided;
- The lamp must be capable of unimpeded expansion when it warms up to operating temperature. Mechanical forces must not be applied to the fused quartz bulb;
- Before the protective jacket is removed, suitable protection must be worn i.e. face mask and gloves with wrist protection;
- Never touch the quartz bulb with bare hands, as fingerprints will make the glass cloudy and cause a severe loss of light. This may also cause recrystallisation and thus

weaken the bulb material. Should the bulb be inadvertently touched, remove fingerprints with methylated spirit and a clean, soft paper towel. The bulb should then be wiped with distilled water. NOTE: ALWAYS WEAR MASK AND GLOVES DURING CLEANING);

In all circumstances the lamp manufacturers data should be referred to when dealing with lamps.

When fitting the lamp:

- Always isolate the equipment from the supply when inserting a lamp;
- Ensure the circuit is suitably fused;
- Ensure the lamp is of the correct power rating and type;
- Check lampholder is in good condition. If the contacts show any sign of corrosion, replace the lampholder;
- Check the lampholder is in a good dry condition. Never allow water to collect in the lamp fitting or come into contact with the lamp.

To fit the lamp:

- Remove the front bezel assembly by operating the safety catch and lifting the latch body;
- For easier access the light shield/spill ring may be removed by undoing the fasteners;
- Cut open one end of the protective sleeve surrounding the lamp;
- Using the sleeve to prevent the fingers coming into contact with the lamp, position the two pins above the holes in the lampholder;
- Gently push the lamp into the lampholder and remove the protective sleeve;
- Replace the light shield/spill ring and front bezel assembly, ensuring the safety catch is engaged.

Testing

Upon correct installation and connection to an electrical supply, the equipment can be tested in order to ensure its' correct performance. A competent person with some knowledge of electrical equipment must carry out this work.

Equipment required: Multi-meter with leads
 Ammeter

Using the equation $P=VI$, the approximate power output of the equipment can be calculated in the following way:

- Using the multi-meter, take a voltage reading;
- Using the ammeter, take an amps reading from the live cable to the lamp;
- Multiply these figures together to give an approximate wattage (Power output).

For example:

Using a 240v 1000w Tungsten halogen lamp:
Voltage reading = 240v ;Amps reading = 4 amps

Therefore, Wattage = $240 \times 4 = 960$ watts

[Back to Top](#)

7- Fault Finding

All fault finding must be conducted by a competent person or qualified Electrical Engineer.

Failure of Lamp to light

Causes:

- 1) Power not supplied;
- 2) Fuse blown;
- 3) Failed lamp

Remedy:

- 1) Check voltage at supply. If supply is not present the fault is at the customer supply. If power is present, see remedy 2;
- 2) Check fuse for visual failure. If none noticeable check fuse for continuity using a multi-meter. If fuse found to be faulty, replace with new part and test equipment again for correct working order. If found to be working correctly see remedy 3;
- 3) Firstly, check supply at lampholder connecting block (within searchlight barrel). If supply is present, disconnect unit from power supply before removing the lamp. If noticeable damage to filament is present, the lamp will have failed. The lamp can also be checked for continuity using a multi-meter. Replace lamp ensuring all precautions and instructions previously outlined in this manual are adhered to.

NOTE: If a fault occurs on the pan and tilt gearbox, the unit should be returned to Francis Searchlights Limited for fault evaluation and repair.

8 - Maintenance and Servicing

In order to prolong the service life and performance of your searchlight, the following maintenance guidelines are recommended:

- Maintenance checks should be conducted before every voyage or at least every three months;
- Before checking, disconnect the equipment from the supply;
- Visually inspect the condition of the equipment;
- Any major or minor structural damage should be rectified immediately in order to reduce sympathetic wear;
- After inspection it may be necessary to clean the inside of the searchlight. The following procedure should be adhered to:
 - Remove the front bezel;
 - Clean the front glass inside and out using a proprietary glass cleaner or metal polish;
 - Clean the reflector if required;
 - Ensure that the lampholder is free from corrosion or other damage;
 - Check earthing point for conductivity;
- It is advisable to check all seals and gaskets for signs of degradation. Renew if necessary;
- Upon completing all maintenance requirements the searchlight should be tested for full working order (approximately 20 minutes).

If in any doubt as to the correct servicing procedures to adopt please contact your distributor/agent or the manufacturer who will be able to advise the best course of action for your product.

9 - Wiring Diagram and General Assembly

Drawing Number	Description
C23015	Wiring Diagram Lite Range Variable Speed 30 Amp
A2651	L560RC 2/3Kw 115/240v Variable Speed General Assembly drawing
C23603	Junction Box Assembly
	Control Panel Assembly

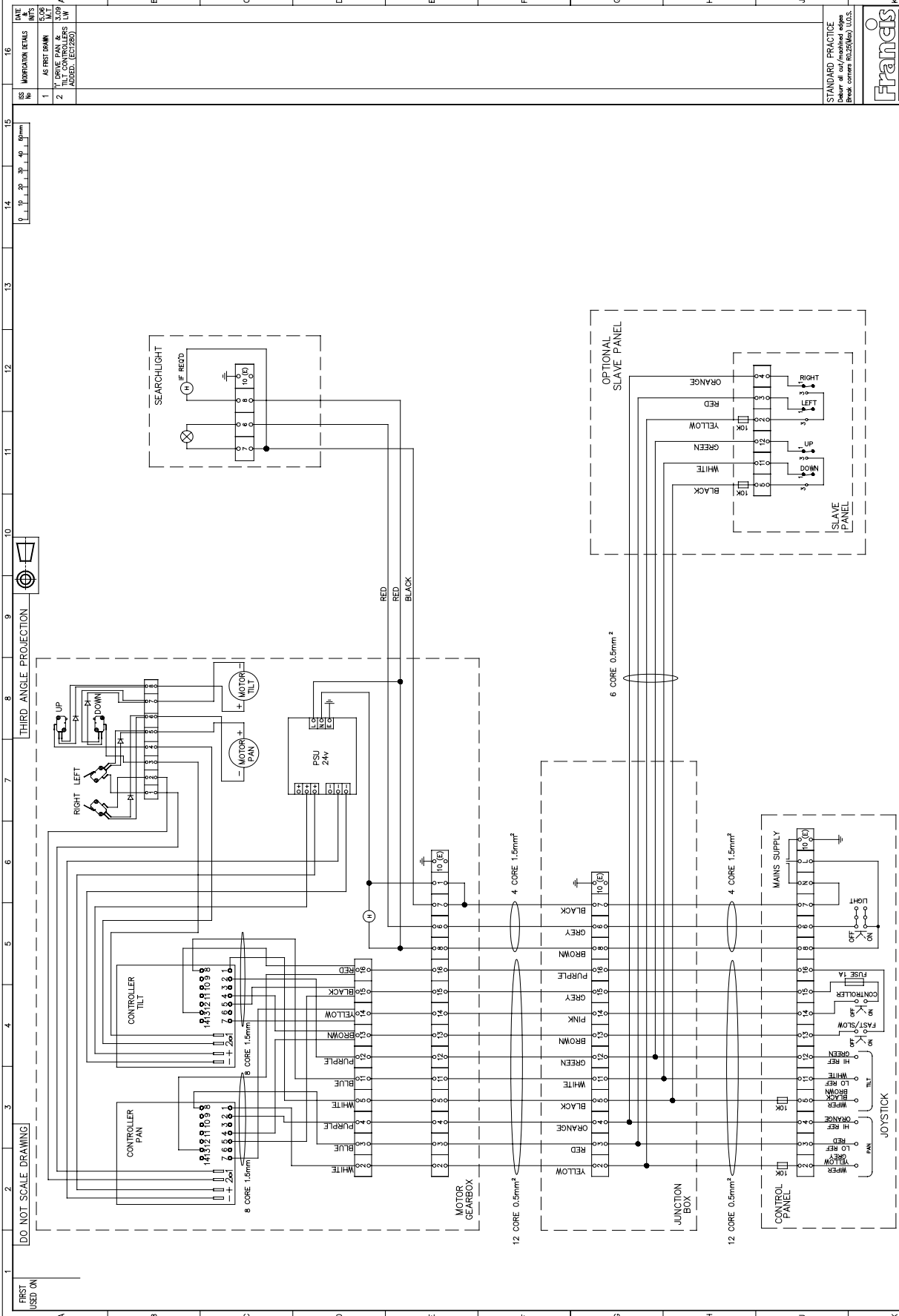

NO	INDICATION DETAILS	DATE	BY	CHKD
1	AS PER DRAWING	11/11/06
2	DRIVE PAN & TILT MOTOR ADDED. (ECT1280)	11/11/06

© 2006 A1	CONT ON SHEET
PART No. 206 No.	SHT
	C23015 1

STANDARD PRACTICE
 Refer to out/included edges
 Refer to centre lines/edges, etc.



FRANCIS SEARCHLIGHTS LIMITED . UNION ROAD . BOLTON . BL2 2HU

WIRING DIAGRAM LITE RANGE VARIABLE SPEED H.V 30 AMP

DRAWN	MARCT DATE	17/5/06	TOLERANCES
CHECKED	SCALE	1:1	See Drawing To ISO 8062 C70
ALL DIMENSIONS IN MILLIMETRES	Angular	±	See Drawing To ISO 8062 C78
	Hole centres & posit.	±	

MATERIAL	DESCRIPTION

FINISH	DESCRIPTION

FINISH	DESCRIPTION

FINISH	DESCRIPTION

FINISH	DESCRIPTION

FINISH	DESCRIPTION

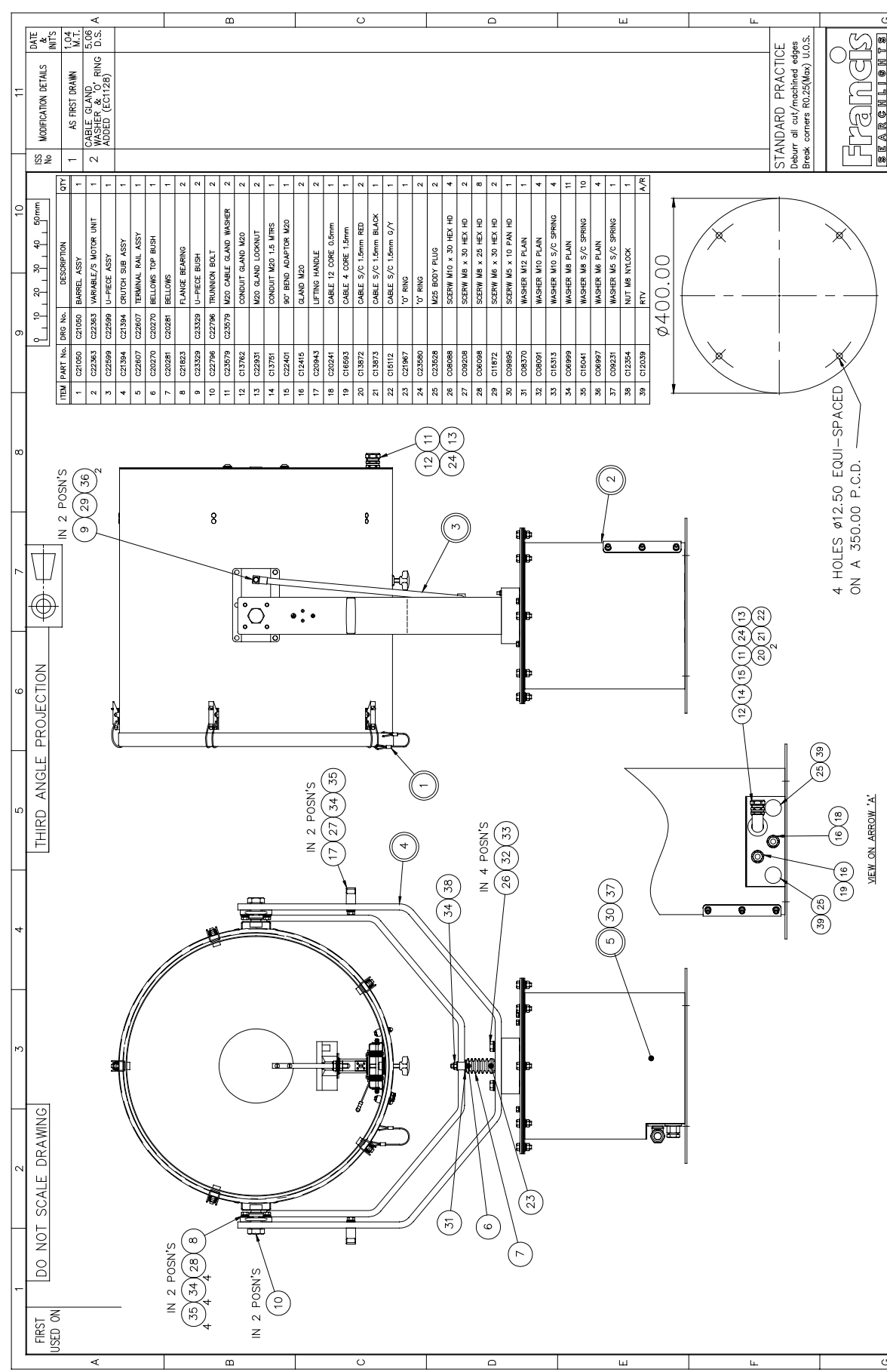

DO NOT SCALE DRAWING

THIRD ANGLE PROJECTION

0 10 20 30 40 50mm

ISS No

MODIFICATION DETAILS

DATE & M/T'S

1 AS FIRST DRAIN

2 CABLE GLAND WASHER & RING ADDED (C1128)

1.04 M.T.

5.06 D.S.

1

2

1

1

1

1

2

3

4

5

6

7

8

9

10

11

12

13

14

15

16

17

18

19

20

21

22

23

24

25

26

27

28

29

30

31

32

33

34

35

36

37

38

39

RTV

A/R

1

2

1

1

1

2

1

1

1

1

1

2

2

2

2

1

1

1

1

1

2

1

1

1

1

1

2

2

2

2

1

1

1

1

1

2

1

1

1

1

1

2

2

2

2

1

1

1

1

1

2

1

1

1

1

1

2

2

2

2

1

1

1

1

1

2

1

1

1

1

1

2

2

2

2

1

1

1

1

1

2

1

1

1

1

1

2

2

2

2

1

1

1

1

1

2

1

1

1

1

1

2

2

2

2

1

1

1

1

1

2

1

1

1

1

1

2

2

2

2

1

1

1

1

1

2

1

1

1

1

1

2

2

2

2

1

1

1

1

1

2

1

1

1

1

1

2

2

2

2

1

1

1

1

1

2

1

1

1

1

1

2

2

2

2

1

1

1

1

1

2

1

1

1

1

1

2

2

2

2

1

1

1

1

1

2

1

1

1

1

1

2

2

2

2

1

1

1

1

1

2

1

1

1

1

1

2

2

2

2

1

1

1

1

1

2

1

1

1

1

1

2

2

2

2

1

1

1

1

1

2

1

1

1

1

1

2

2

2

2

1

1

1

1

1

2

1

1

1

1

1

2

2

2

2

1

1

1

1

1

2

1

1

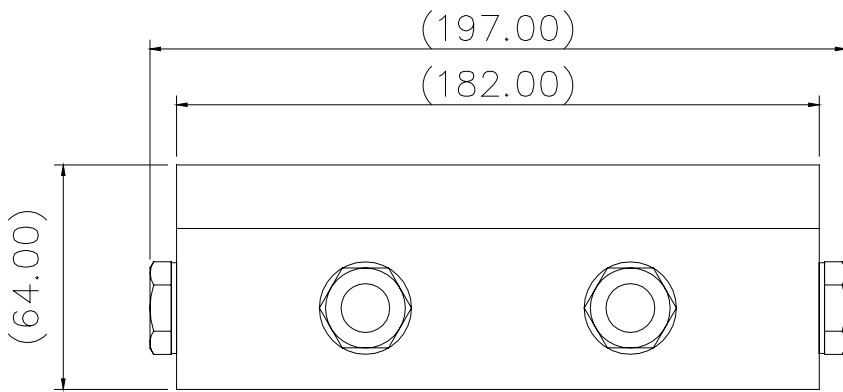
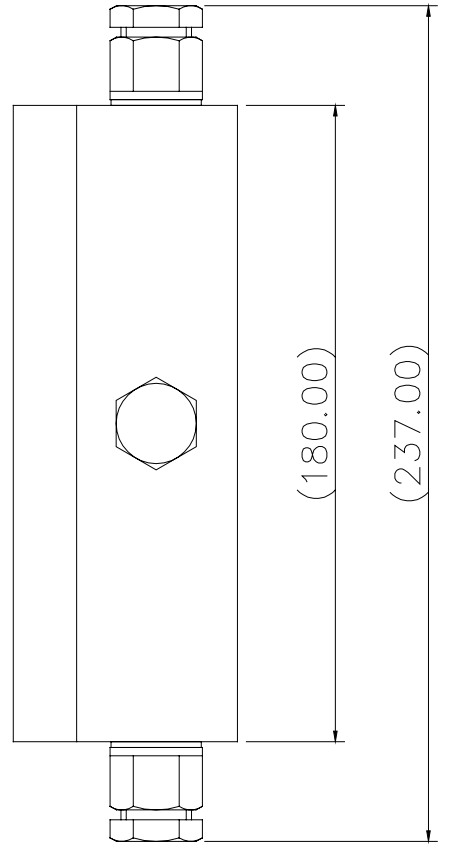
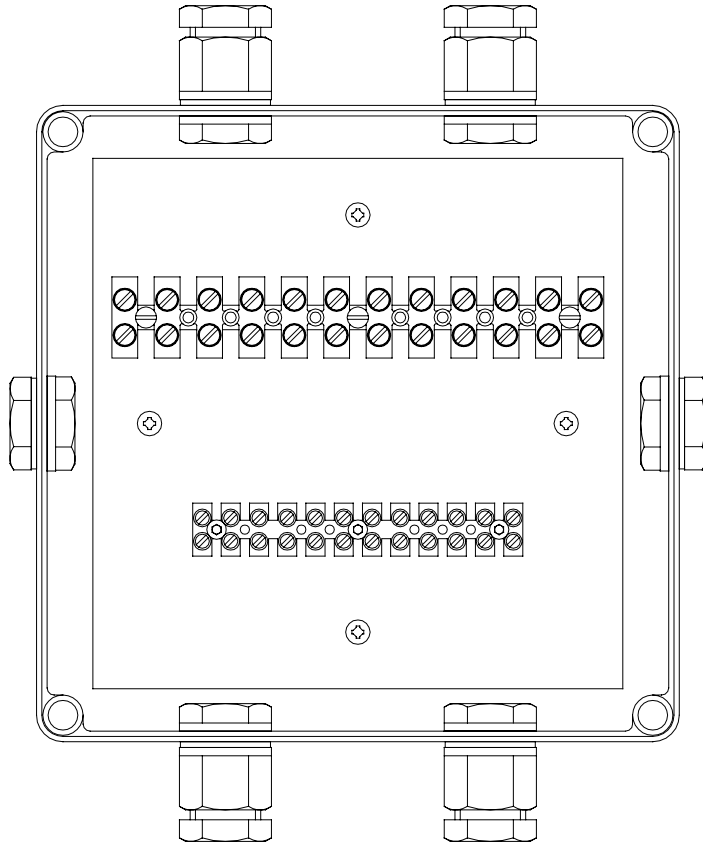

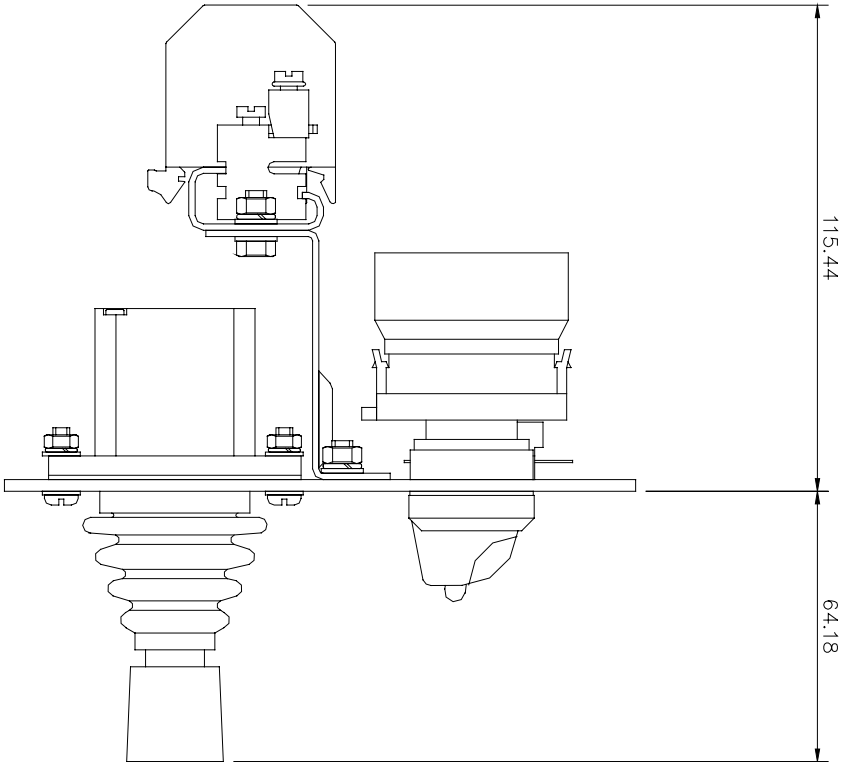
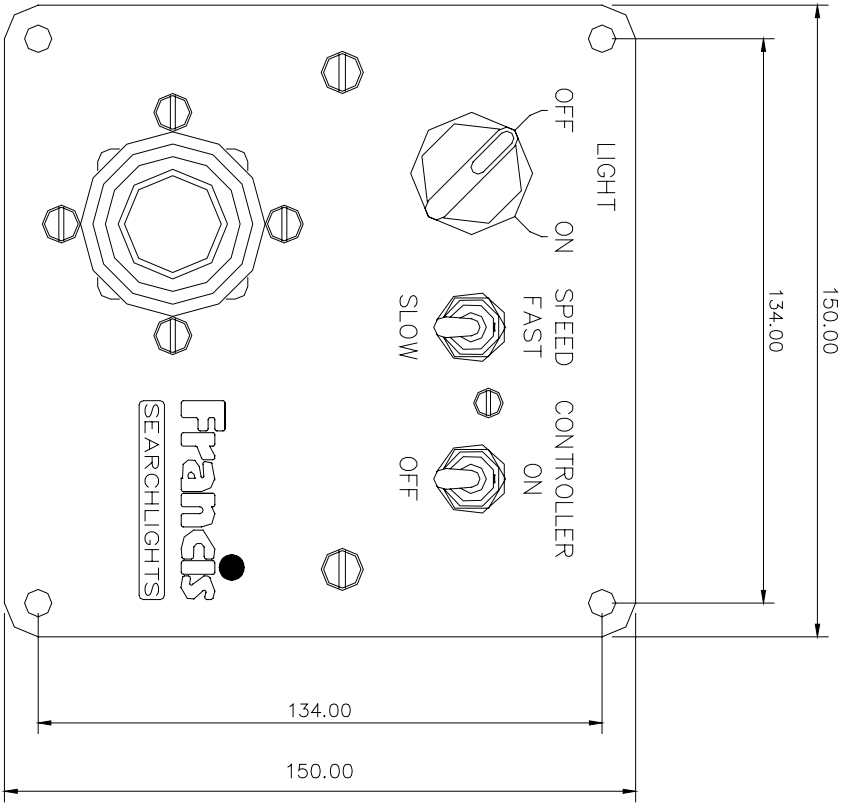

10 - Spare Parts List

The following spare parts can be ordered directly from the manufacturer:

Part Number	Description
Searchlight Spares	
D1823	115v 2Kw G38 Tungsten Halogen Lamp
D4604	220/240v 2Kw G38 Tungsten Halogen Lamp
D9843	115v 3Kw G38 Tungsten Halogen Lamp
D22559	220/240v 3Kw G38 Tungsten Halogen Lamp
C23012-00	Selector Switch 30Amp – On/Off
C22347-00	Joystick
C20550-00	Latch
C20881-00	Front Glass
C20569-00	Front Glass Gasket
C21051-00	Reflector
C22268-01	Breather unit
C09868-00	Lampholder G38
C16761-00	A.V. mount
C20281-00	Bellows
Motor Gearbox Spares	
C20261-00	Heater
C22403-01	Pan Motor S/Assy
C22287-00	Tilt Motor
C22380-00	Microswitch no lever
C22382-00	Microswitch with lever
C24030-01	'I' Drive Pan Speed Controller
C24060-01	'I' Drive Tilt Speed Controller
C23530-00	P.S.U
C22381-00	Pedestal Top Sealing Gasket
C21225-00	Pedestal Cover Gasket

In order to prolong the life and performance of your product, we recommend that you only specify Francis Searchlights spare parts. This will ensure that any warranties on your equipment will not be invalidated.

When ordering spare parts please contact the Sales Department at Francis Searchlights Limited. Please quote searchlight model and serial number at all times. This will enable a fast response to your spares' requirements.