



FR300RC Explorer
Issue 1 Halogen
Remote Control

APPLICATION

The NEW FRANCIS FR EXPLORER is part of the premium Range of Remote Control searchlights has been designed with the precise aim of bringing to the market, the ultimate searchlight able to guarantee high performance, strength and affordability.

The Premium FR300RC Explorer has been carefully developed to withstand the extraordinary conditions while in use in the harshest of environment, such as Coast Guard patrol. The heavy duty gearbox is strong, powerful and able to operate in the rough seas and high strength winds as found in coastal areas such as Canada and Scandinavia. This range now also has the added benefit of a heater fitted to the gearbox as standard, allowing an operation temperature of up to -50 °c.

PART NUMBERS

Type	Supply	L/holder	Part Number
FR300 RC	24v	GX6.35	A2536
FR300 RC	240/115v	GX9.5	A2537

SPECIFICATION

- Constructed from marine grade brass and stainless.
- Parabolic form, polished glass mirror.
- Stove enamel painted.
- Joystick control panel supplied.
- Remote focus fitted as standard.
- Toughened front glass.
- Sealing to IP66 Gearbox – IP 56 Searchlight.
- Tungsten Halogen light source.
- Remote elevation control +25° to -25°.
- Remote pan rotation 365°.
- Rotation speed 20°/sec.
Elevation speed 5°/sec
- Operational temperature -50° C.
- Heater standard in gearbox and optional in barrel.

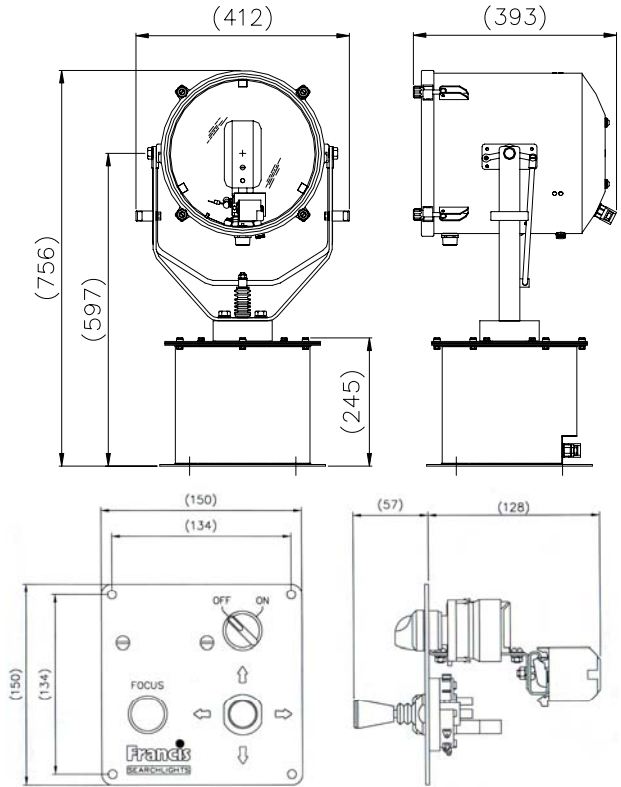

All Dimensions in Millimetres

Base fixings

4 holes Ø12.5 on a 290 PCD

Weight 27.8 Kgs

A pedestal mounting option is available upon request.

Performance Data * Inclusive angle

Volt's	Lamp life	Range (m)	PBCP x1000	*Div	Watts	Lamp Cap	Lamp Part Number
24v	300	1055	1113	2	150	GX6.35	D14795
24v	2000	1238	1532	3	250	GX6.35	D4695
24v	300	1490	2220	3	250	GX6.35	D9851
230v	750	905	820	5	650	GX9.5	D1813
115v	750	1000	1000	5	1000	GX9.5	D1809
230v	750	970	940	5	1000	GX9.5	D6715

Francis Searchlights Limited
 Union Road, Bolton, BL2 2HJ, UK
 Tel 44 (0) 1204 558960 Fax 44 (0) 1204 558979
 Email sales@francis.co.uk Web site www.francis.co.uk

For more information contact: