



APPLICATION

The FRANCIS Lite range of searchlights incorporate the design features required to successfully operate searchlights in the most demanding product operating environments on land and sea.

The L380 has excellent illumination characteristics, a powerful, focusable beam and is suitable for use on works boats, smaller cargo vessels and bridge wing projectors.

PART NUMBERS

Type	Part Number
L380 Deck 110/240v	A2587
L380 Deck 24v	A2591
Cabin Control Assembly	C22314-01
Deck Pedestal	C20636-79
Cabin Pedestal Assembly	C22317-01

SPECIFICATION

- Constructed from 304 stainless steel.
- Parabolic formed aluminium reflector.
- Powder coated finish.
- External lamp focus adjustment.
- Toughened front glass.
- Spill rings to prevent unwanted glare & stray light.
- Tungsten Halogen light source.
- Sealing to IP66.
- Special "B1", "B2" & "C2" dimensions available on request.
- Full 450° rotation.
- Vertical movement +45° to - 45° (Deck/Deck Ped).
- Vertical movement +30° to - 25° (Cabin/Cabin Ped).
- Supplied in modular form to allow the customer any configuration possibility.

Performance Data * Inclusive angle

Volt's	Lamp life	Range (m)	PBCP x1000	*Div	Watts	Lamp Cap	Lamp Part Number
24v	300 hs	1311	1718	2	150	GX6.35	D14795
24v	2000 hs	1390	1932	2.5	250	GX6.35	D4695
24v	300 hs	1673	2800	3	250	GX6.35	D9851
115v	750 hs	1249	1560	6	1000	GX9.5	D1809
230v	750 hs	1114	1240	5	650	GX9.5	D1813
230v	750 hs	1210	1465	5	1000	GX9.5	D6715

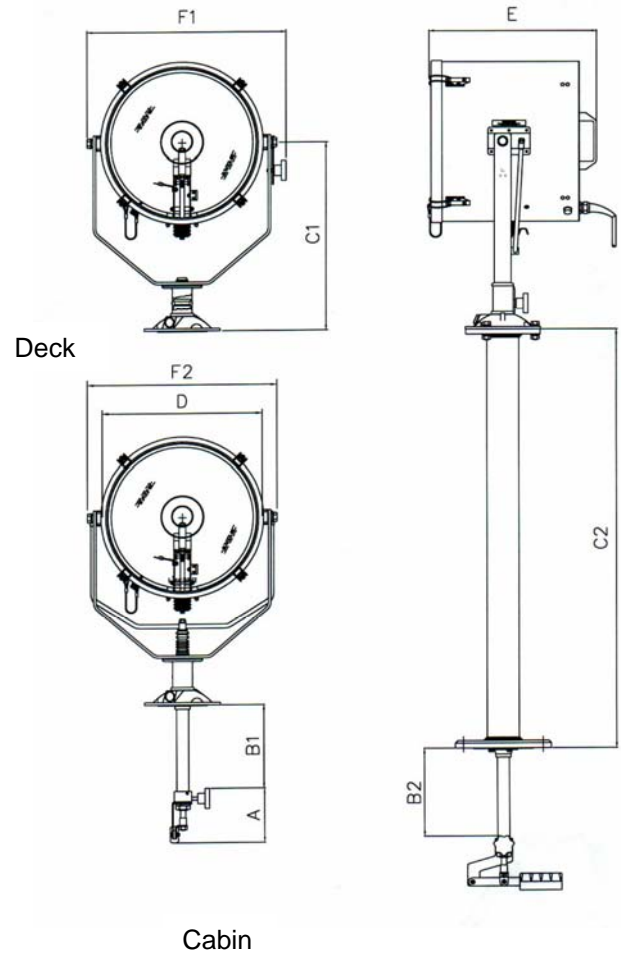

All Dimensions in Millimetres

Base fixings

Deck & Cabin. 3 holes Ø11 on a 154 PCD
Deck Ped. & Cabin Ped 4 holes Ø12.5 on a 190 PCD
Cabin & Cabin Ped. Central hole Ø75

Dimensions

A	B1	B2	C1	C2	D	E	F1	F2
130	199	211	450	1004	380	400	473	451

Weights

L380 Deck	13.5 Kgs
Cabin Control Assembly	2.80 Kgs
Deck Pedestal	5.00 Kgs
Cabin Pedestal Assembly	3.80 Kgs

Francis Searchlights Limited
Union Road, Bolton, BL2 2HJ, UK
Tel 44 (0) 1204 558960 Fax 44 (0) 1204 558979
Email sales@francis.co.uk Web site www.francis.co.uk

For more information contact: